

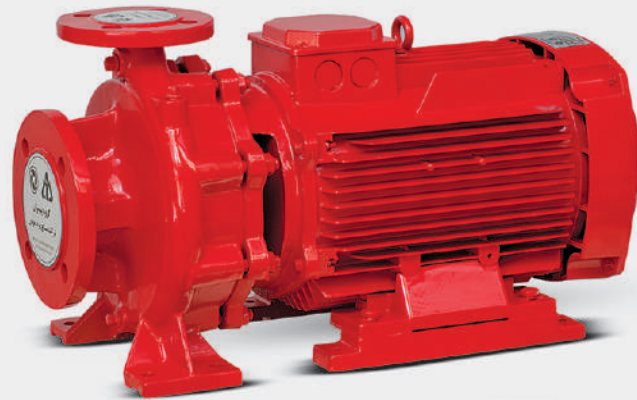

شرکت صنایع نویدموتور
گروه پمپیران

الکتروپمپ‌های اتابلوک



ETABLOC ELECTROPUMPS





NAVIDMOTOR

PUMPIRAN GROUP

Navid Motor Industries Company located at 35km of historical and industrial city of Tabriz. Navid Motor produce different kind of electropumps both in linear and foot mounted types for household, industrial and urban appliances. Now the company has more than 200 employees and produces more than 400 different types of electropumps in a 24000 square meter area and is the important producer of electropump in the Middle East.

شرکت صنایع نوید موتور در ۳۵ کیلومتری شهر تاریخی و صنعتی تبریز تاسیس شده است. هدف این شرکت تولید انواع الکتروپمپ‌های زمینی و خطی برای انواع مصارف صنعتی و خانگی و شهری می‌باشد. هم اکنون این شرکت با بیش از ۲۰۰ نفر پرسنل و با تولید بیشتر از ۴۰۰ تیپ انواع پمپ و الکتروپمپ در مساحتی حدود ۲۴۰۰۰ متر مربع یکی از بزرگترین تولید کنندگان الکتروپمپ در منطقه می‌باشد.

الکتروپمپ‌های اتابلوک

Applications :

Close-coupled electropump. This machine is ideal for different usage as domestic, industrial, heating and cooling systems, firefighting, urban and etc. The suitable fluid for this product is fluid with physical properties as same as water without any solid particles.

Motor

- four pole & two pole induction motor (1450 & 2900 rpm)
- protection IP54
- Electromotor with IEC standard

Operating Conditions

- Liquid temperature up to 120° C
- Ambient temperature up to 60° C
- Maximum pressure 16bar
- Continuous duty and without need to maintenance

Materials

- Pump body Cast iron / Bronze / Steel
- Impeller Cast iron / Bronze / Steel
- Shaft Ck45 / Stainless Steel
- Sealing Mechanical Seal

کاربردها :

الکتروپمپ بدون کوبلینگ که مناسب جهت استفاده در انواع سیستم‌های تاسیسات خانگی، صنعتی، سرمایش و گرمایش، آتش‌نشانی، استخری، کشاورزی و... می‌باشد. سیال مورد استفاده در این دستگاه سیالی با مشخصات فیزیکی آب بدون ذرات جامد می‌باشد.

موتور

- القائی چهارپل و دوپل (۱۴۵۰ و ۲۹۰۰ دور بر دقیقه)
- درجه حفاظتی IP54
- الکتروموتورهای مورد استفاده سه فاز و تکفاز مطابق با استاندارد IEC

نکات کاری

- حداکثر دمای سیال ۱۲۰ درجه‌ی سانتیگراد
- حداکثر دمای محیط ۶۰ درجه‌ی سانتیگراد
- حداکثر فشار کاری ۱۶ بار
- دائم کار و بدون نیاز به سرویس و نگهداری

جنس مواد

- محفظه چدن / برنز / استیل
- پروانه چدن / برنز / استیل
- محور CK / استیل
- آب بندی سیل مکانیکی



ETABLOC ELECTROPUMP

روش نام گذاری سری اتابلوک

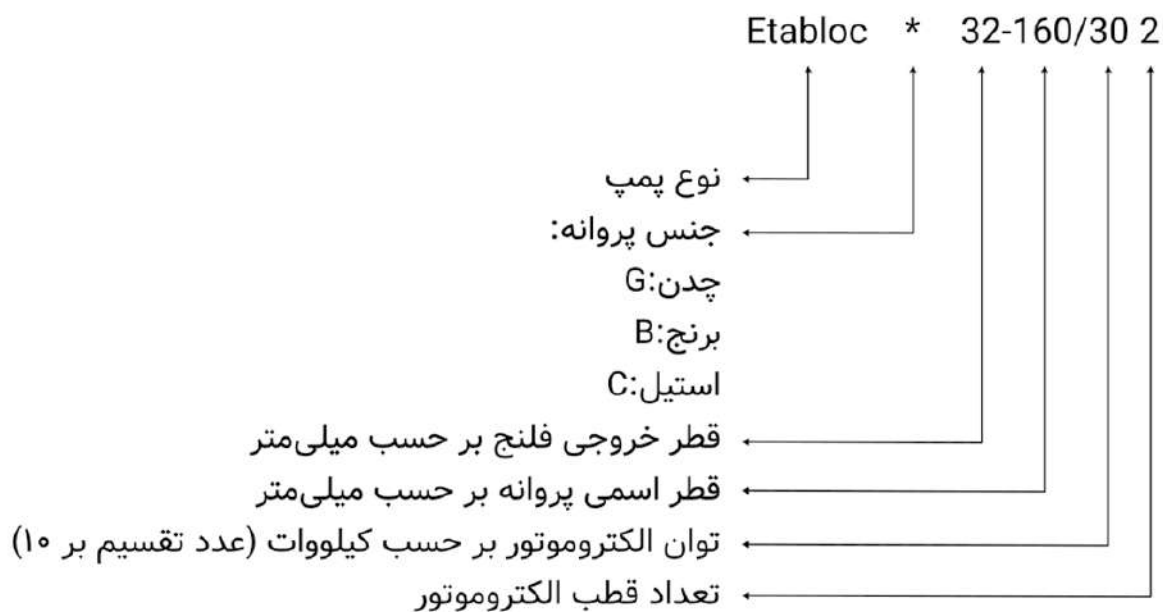

جدول اطلاعات فلنج های محفظه حلزونی

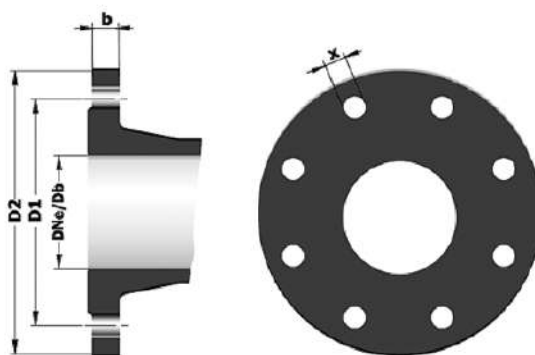

DNe/Db	Suction & Discharge (PN16)				
	D2	D1	X	Z	b
32	140	100	19	4	17
40	150	110	19	4	17
50	165	125	19	4	19
65	185	145	19	4	19
80	200	160	19	8	19
100	220	180	19	8	21
125	250	210	19	8	23
150	285	240	23	8	23
200	340	295	23	12	27
250	405	355	27	12	27

منحنی‌های همپوشانی الکترومپ‌ها

1450 rpm

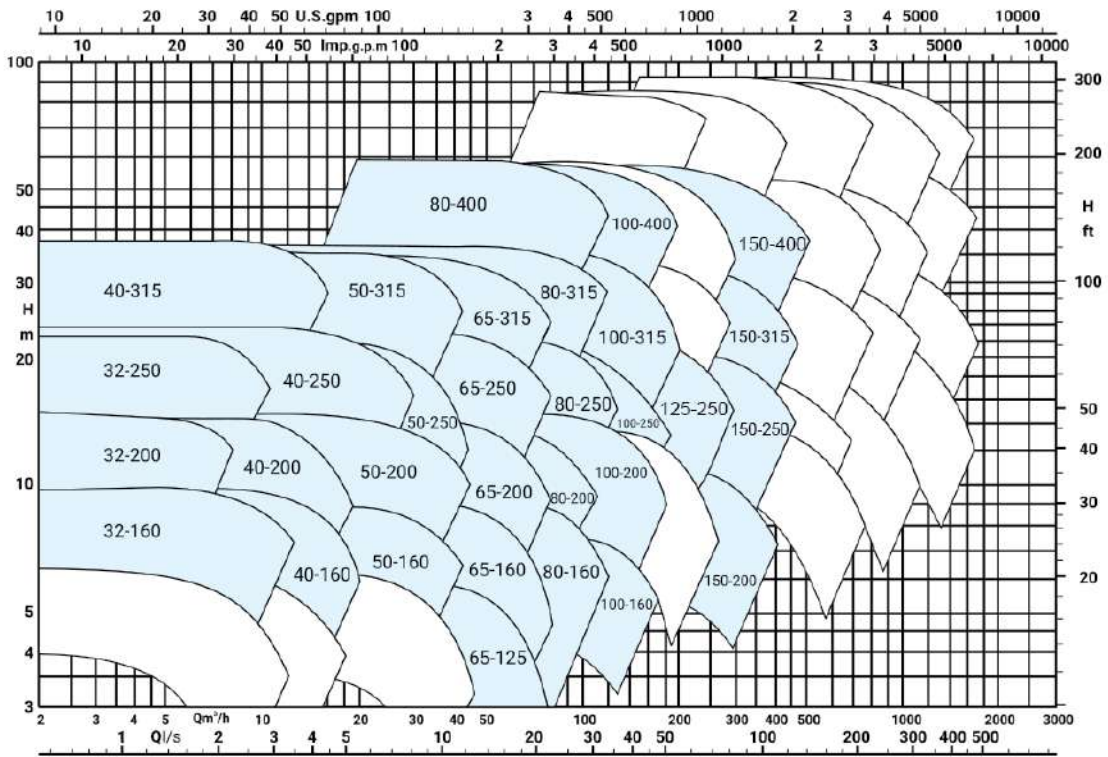

2900 rpm

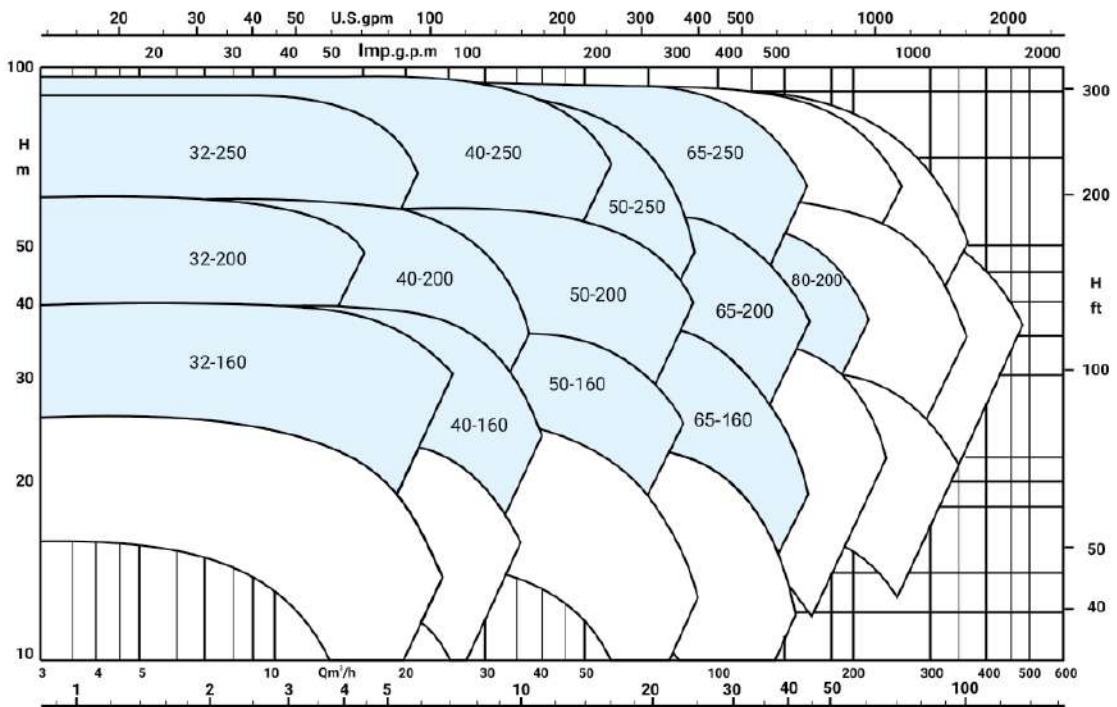



شرکت صنایع نوید موتور
گروه پمپیران

الکتروپمپ‌های اتابلوک ETABLOC PUMP SERIES



مشخصات ابعادی الکتروپمپ‌های اتابلوک

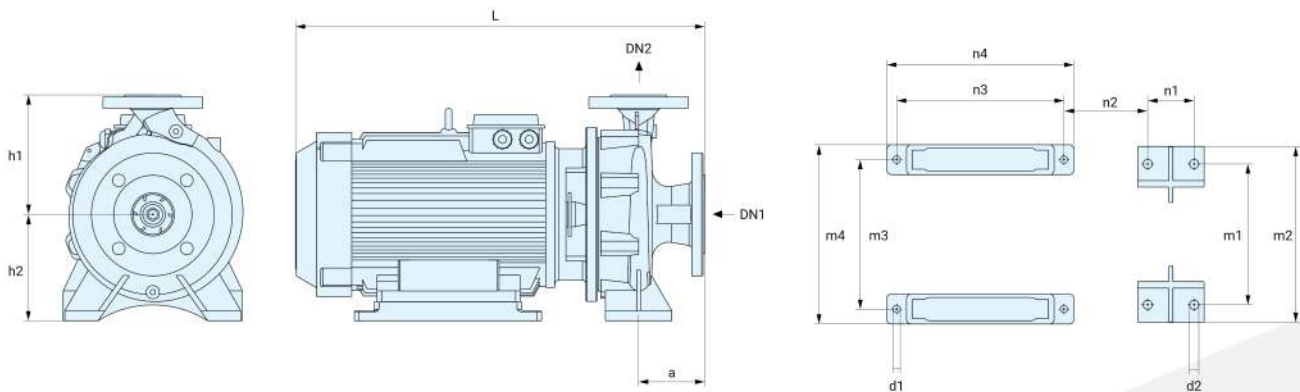

جدول مشخصات اتابلوک های 2900rpm

Etabloc Pump		Pump Dimension(mm)															
Pump Type	Weight (kg)	DN1	DN2	h1	h2	L	a	n1	n2	n3	n4	m1	m2	m3	m4	d2	d1
Etabloc G 32-160/302	50	50	32	160	132	500	80	70	103	204	234	190	240	160	200	14	11
Etabloc G 32-160/402	58	50	32	160	132	514	80	70	108	204	234	190	240	195	235	14	11
Etabloc G 32-200/402	66	50	32	180	160	514	80	70	109	204	234	190	240	195	235	14	11
Etabloc G 32-200/552	79	50	32	180	160	592	80	100	117	252	282	190	240	225	270	14	11
Etabloc G 32-250/752	95	50	32	225	180	627	100	95	123	252	282	250	320	225	270	14	11
Etabloc G 32-250/1102	126	50	32	225	180	742	100	95	136	340	369	250	320	264	320	14	11
Etabloc G 32-250/1502	142	50	32	225	180	742	100	95	136	340	369	250	320	264	320	14	11
Etabloc G 40-160/552	80	65	40	180	160	610	80	70	174	178	252	190	240	225	270	14	11
Etabloc G 40-200/552	81	65	40	180	160	617	100	70	125	252	282	212	265	225	270	14	11
Etabloc G 40-200/752	86	65	40	180	160	617	100	70	125	252	282	212	265	225	270	14	11
Etabloc G 40-200/1102	115	65	40	180	160	742	100	70	191	255	305	212	265	250	320	14	15
Etabloc G 40-250/1102	132	65	40	225	180	742	100	95	136	340	369	250	320	264	320	14	11
Etabloc G 40-250/1502	147	65	40	225	180	742	100	95	136	340	369	250	320	264	320	14	11
Etabloc G 40-250/1852	150	65	40	225	180	742	100	95	136	282	369	250	320	285	320	14	11
Etabloc G 40-250/2202	223	65	40	225	180	805	100	95	192	282	330	250	320	285	360	14	14
Etabloc G 50-160/552	82	65	50	180	160	630	100	70	137	252	282	212	265	225	270	14	11
Etabloc G 50-160/752	87	65	50	180	160	630	100	70	137	252	282	212	265	225	270	14	11
Etabloc G 50-200/1102	115	65	50	200	160	742	100	75	191	255	305	212	320	262	320	14	15
Etabloc G 50-200/1502	132	65	50	200	160	742	100	75	191	255	305	212	320	262	320	14	15
Etabloc G 50-200/1852	135	65	50	200	160	742	100	75	191	255	305	212	320	262	310	14	15
Etabloc G 50-250/1102	116	65	50	225	180	742	100	95	136	340	369	250	315	264	310	14	11
Etabloc G 50-250/1502	131	65	50	225	180	742	100	95	136	340	369	250	315	264	310	14	11
Etabloc G 50-250/1852	142	65	50	225	180	742	100	95	136	340	369	250	315	264	310	14	11
Etabloc G 50-250/2202	227	65	50	225	180	810	100	95	192	282	330	250	315	285	360	14	14
Etabloc G 50-250/3002	290	65	50	225	200	953	100	95	304	305	365	250	315	335	396	18	14
Etabloc G 65-160/1102	110	80	65	200	160	741	100	95	179	225	305	212	280	254	319	14	15
Etabloc G 65-160/1502	130	80	65	200	160	741	100	95	179	225	305	212	280	254	319	14	15
Etabloc G 65-200/2202	230	80	65	225	180	790	100	95	190	282	330	250	320	279	360	14	14
Etabloc G 65-250/3002	310	80	65	250	200	963	100	120	301	305	365	280	360	335	396	18	18
Etabloc G 65-250/3702	335	80	65	250	300	963	100	120	301	305	365	280	360	335	396	18	18
Etabloc G 65-250/4502	395	80	65	250	225	993	100	120	317	311	371	280	360	356	436	18	18
Etabloc G 65-250/5502	500	80	65	250	280	1108	100	120	271	449	485	280	360	388	486	18	18
Etabloc G 80-200/2202	262	100	80	250	180	825	125	95	195	279	330	280	345	285	360	14	14
Etabloc G 80-200/3002	314	100	80	250	200	987	125	95	314	305	365	280	345	320	396	14	18
Etabloc G 80-200/3702	338	100	80	250	200	987	125	95	314	305	365	280	345	320	396	14	18

Electrical Data				
IP	Current (A) 3 Phase	Voltage (V)	Power (kw)	Speed (rpm)
54	6.5	380Y	3	2900
54	9	380Δ	4	2900
54	9	380Δ	4	2900
54	11.6	380Δ	5.5	2900
54	15.6	380Δ	7.5	2900
54	21.3	380Δ	11	2900
54	29	380Δ	15	2900
54	11.6	380Δ	5.5	2900
54	11.6	380Δ	5.5	2900
54	15.6	380Δ	7.5	2900
54	21.3	380Δ	11	2900
54	21.3	380Δ	11	2900
54	29	380Δ	15	2900
54	36.3	380Δ	18.5	2900
54	42.3	380Δ	22	2900
54	11.6	380Δ	5.5	2900
54	15.6	380Δ	7.5	2900
54	21.3	380Δ	11	2900
54	29	380Δ	15	2900
54	36.3	380Δ	18.5	2900
54	21.3	380Δ	11	2900
54	29	380Δ	15	2900
54	36.3	380Δ	18.5	2900
54	42.3	380Δ	22	2900
54	54.4		30	2900
54	21.3	380Δ	11	2900
54	29	380Δ	15	2900
54	42.3	380Δ	22	2900
54	54.4	380Δ	30	2900
54	67.9	380Δ	37	2900
54	82.6	380Δ	45	2900
54	97.7	380Δ	55	2900
54	42.3	380Δ	22	2900
54	54.4	380Δ	30	2900
54	67.9	380Δ	37	2900

منحنی‌های همپوشانی الکتروپمپ‌ها

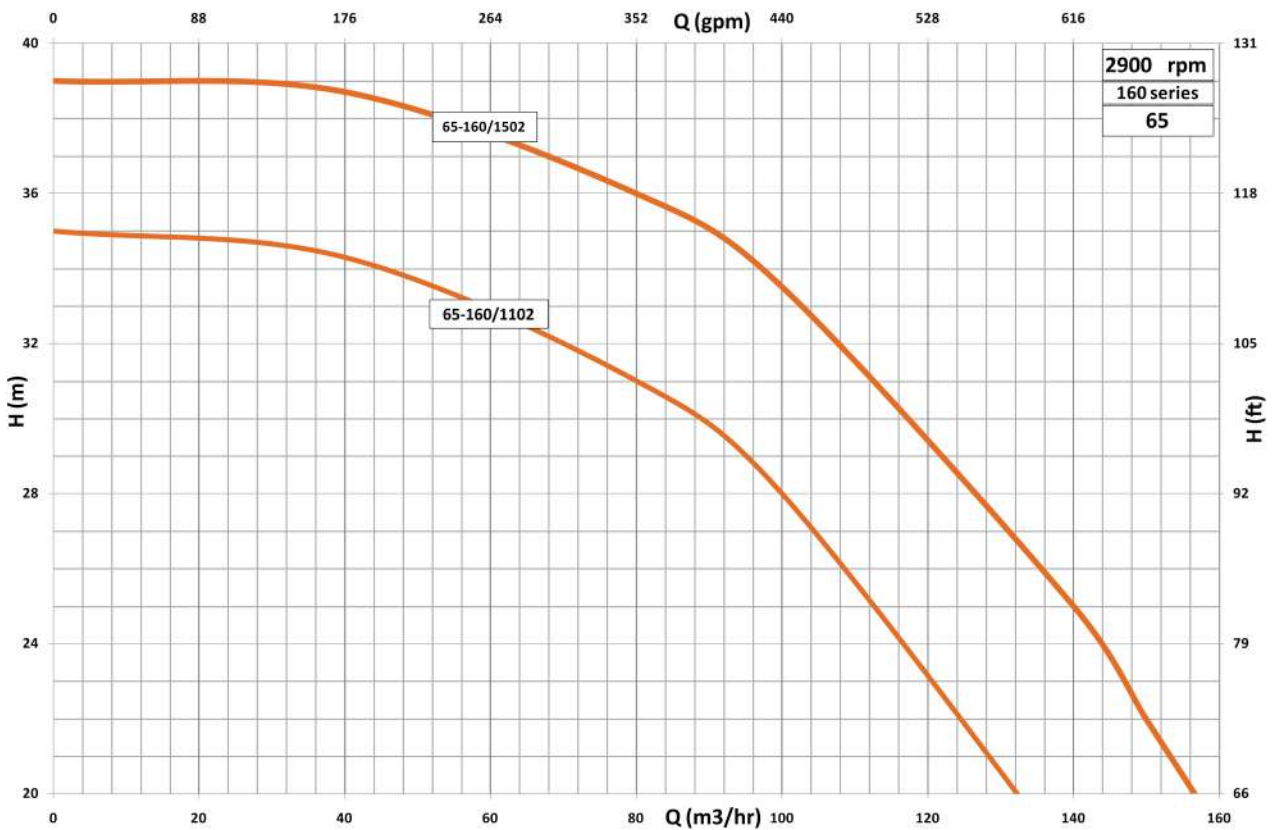
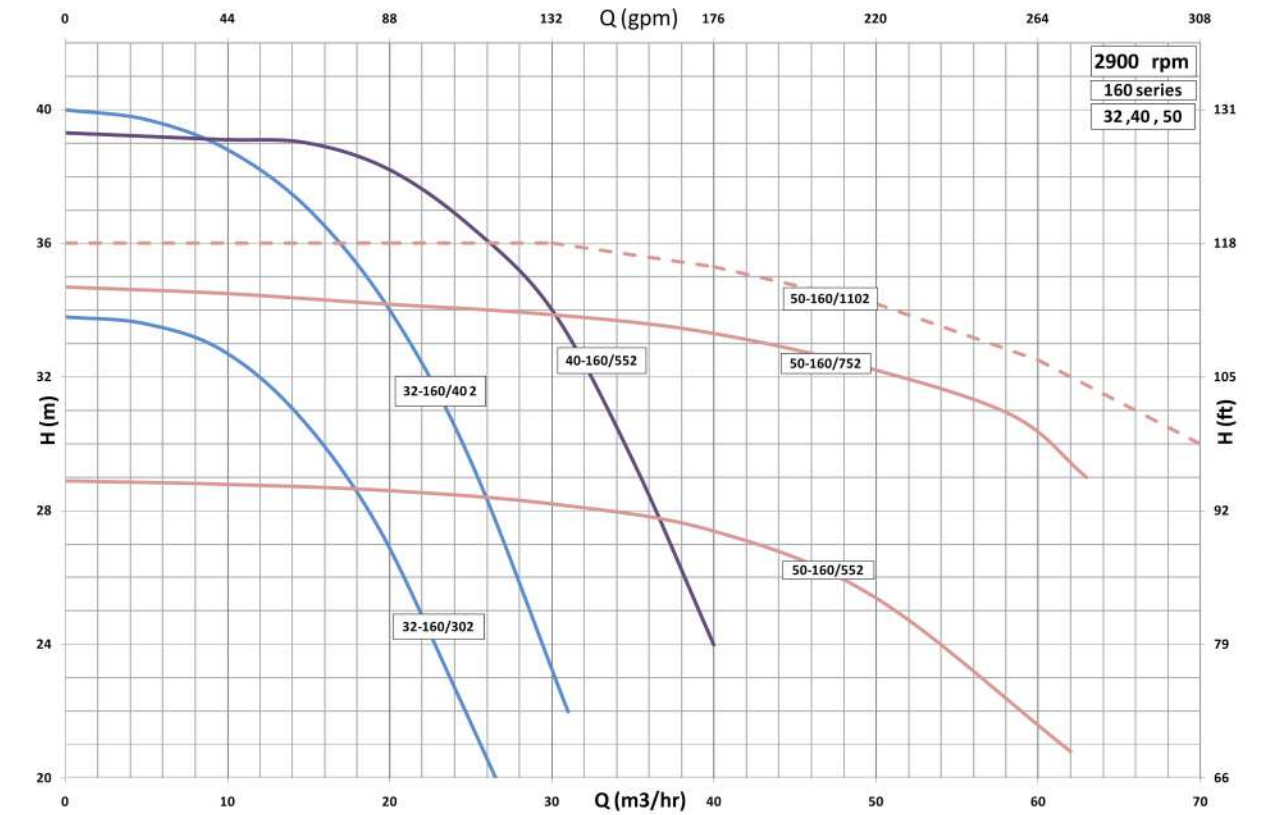

منحنی‌های همپوشانی الکتروپمپ‌ها

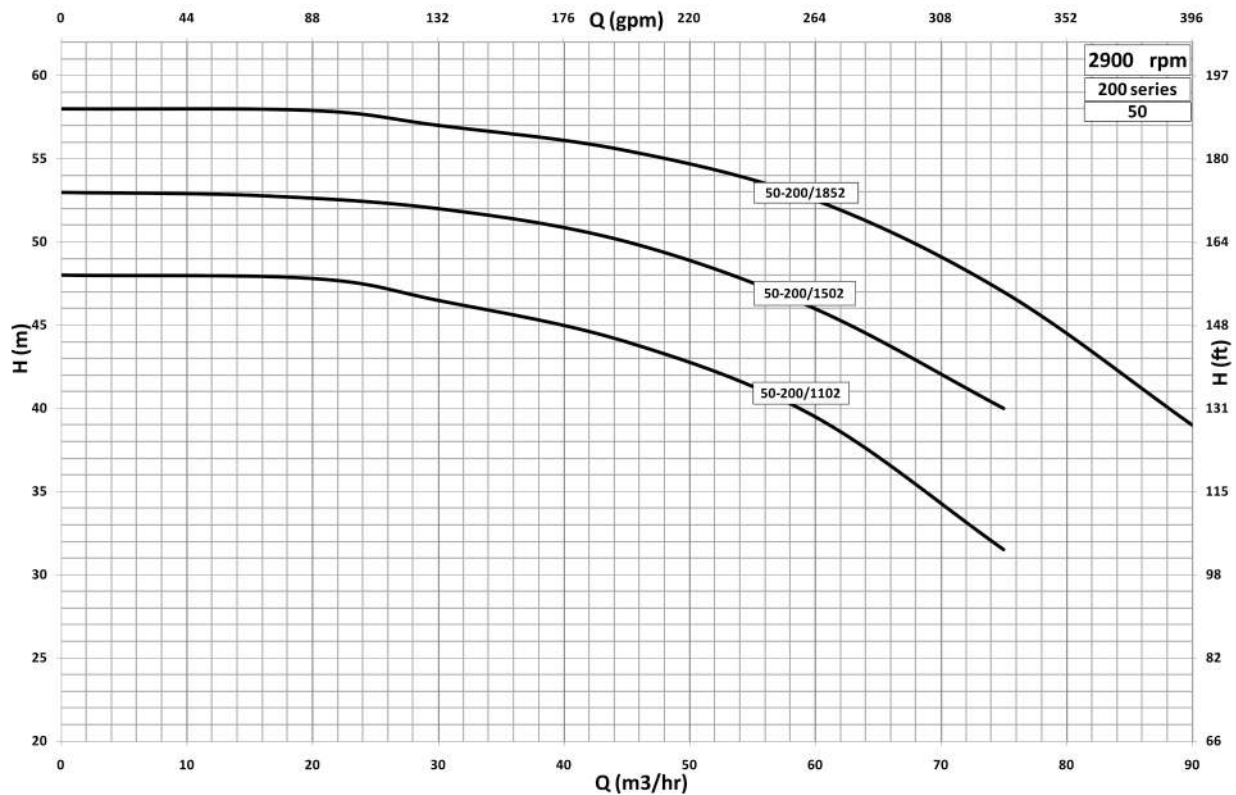
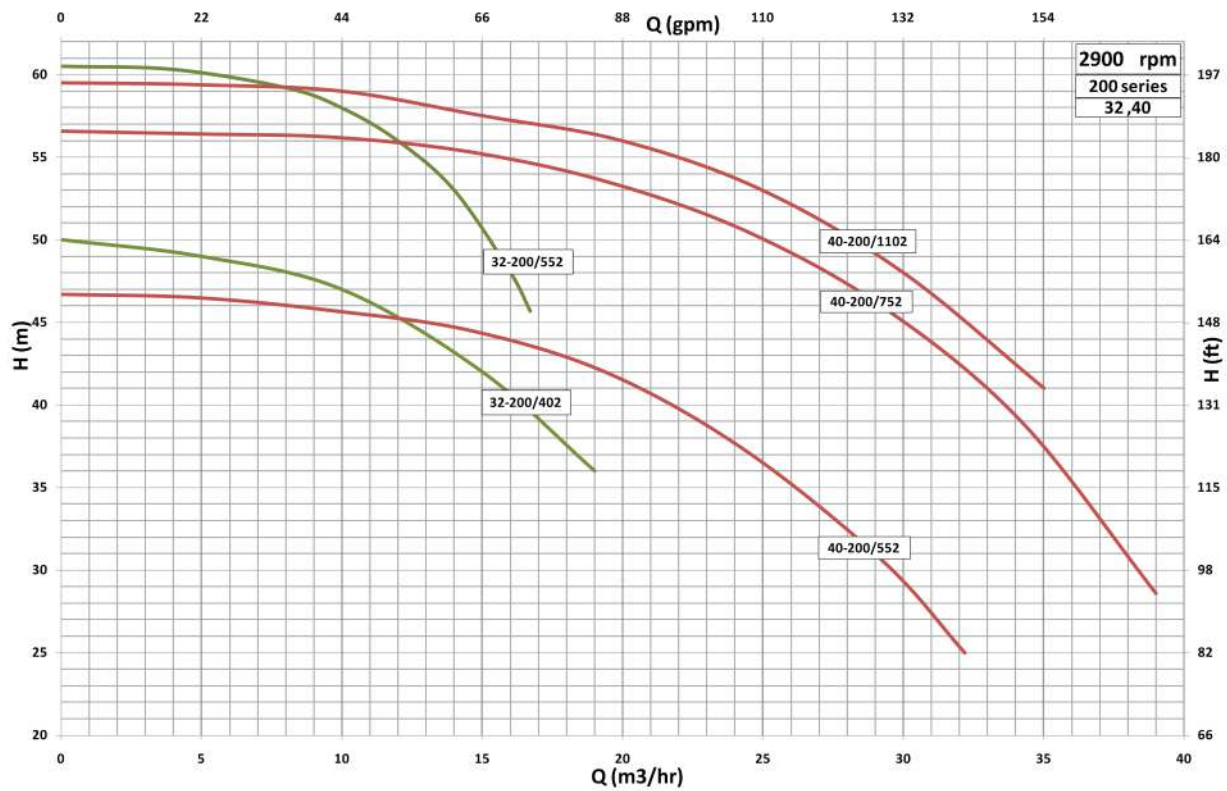

منحنی‌های همپوشانی الکترومپ‌ها

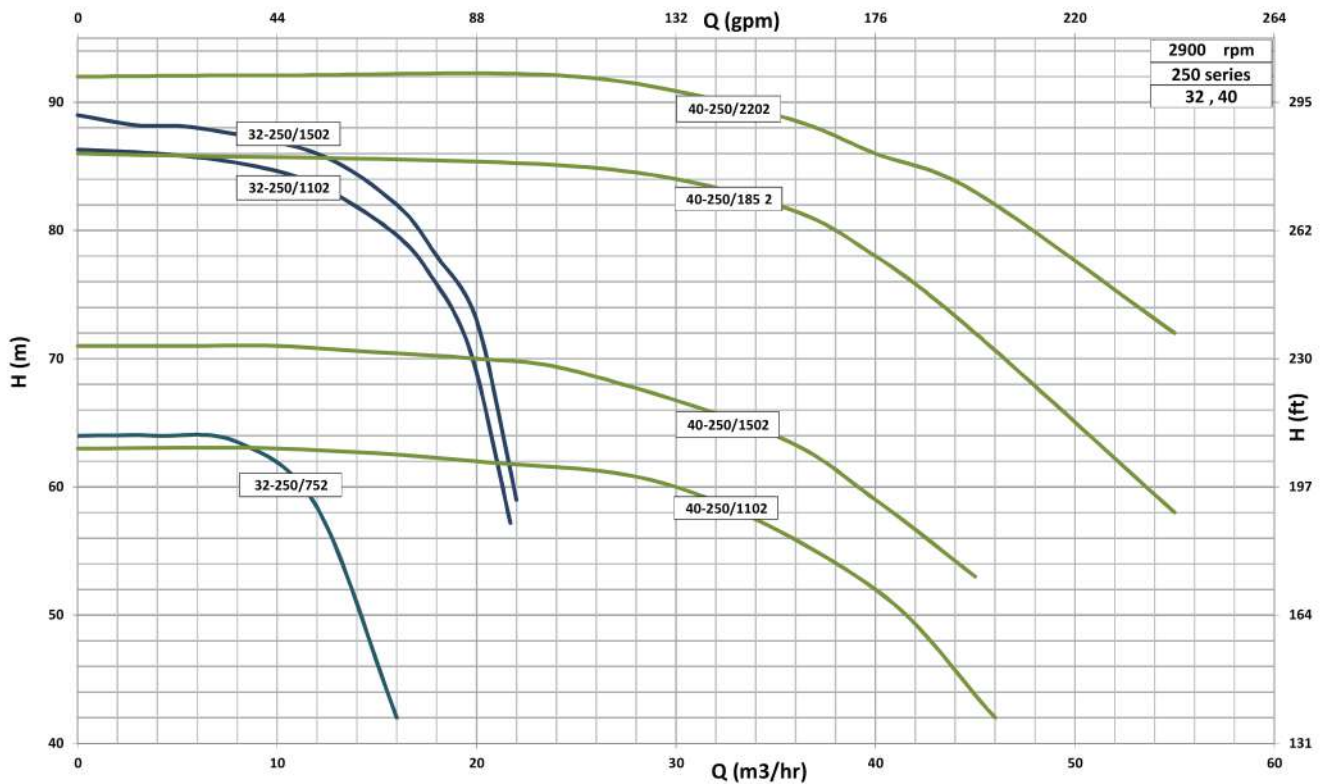
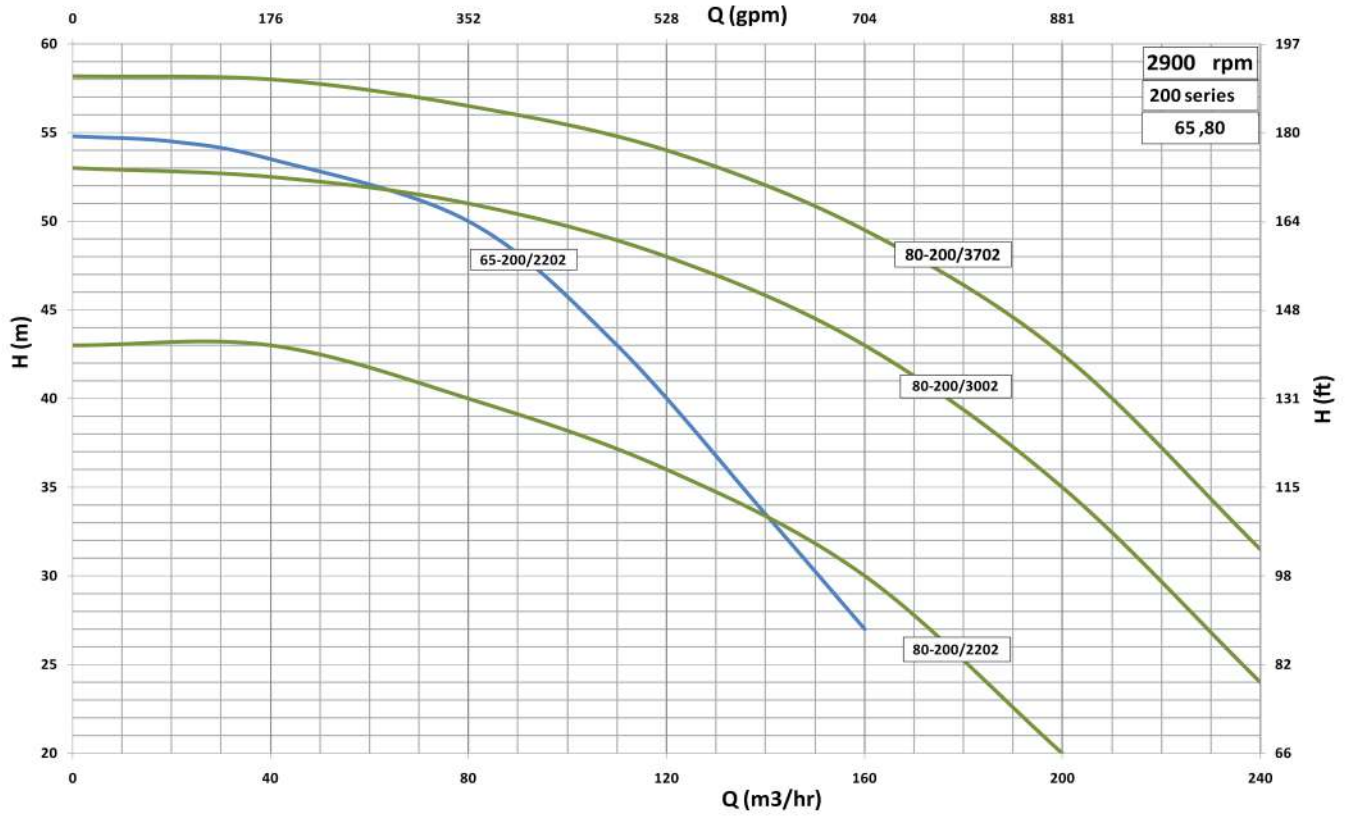

منحنی‌های همپوشانی الکتروپمپ‌ها

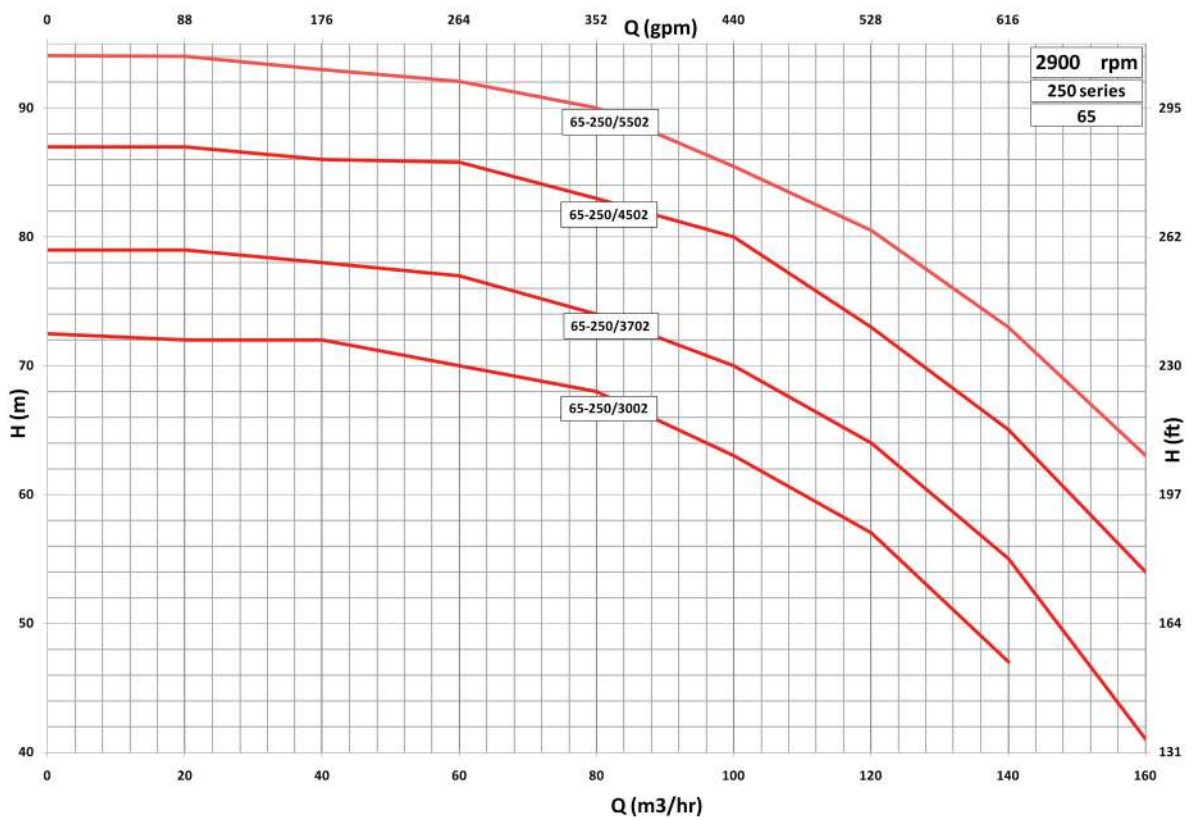
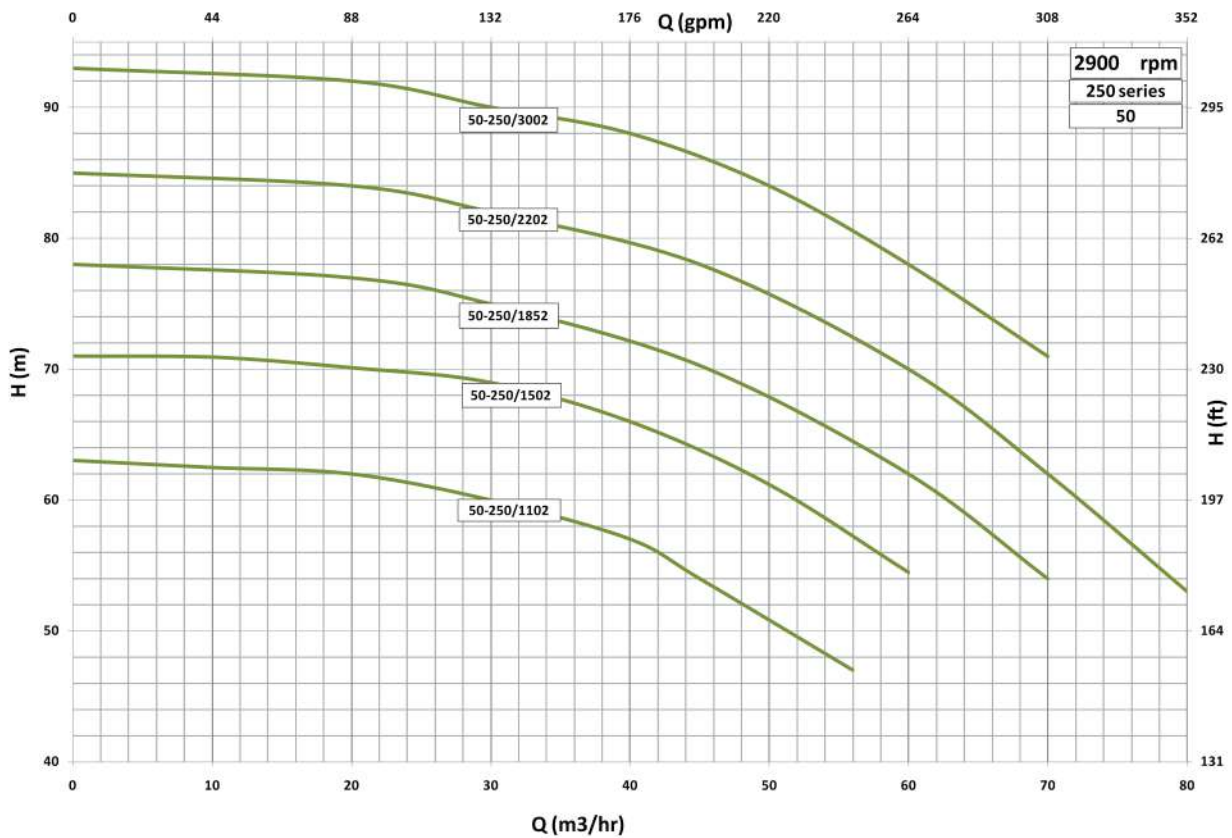

Etabloc Pump		Pump Dimension(mm)															
Pump Type	Weight (kg)	DN1	DN2	h1	h2	L	a	n1	n2	n3	n4	m1	m2	m3	m4	d2	d1
Etabloc G 32-160/074	20	50	32	160	132	435	80	70	105	156	184	190	240	125	160	14	11
Etabloc G 32-200/054	47	50	32	180	160	435	80	70	105	156	184	190	240	125	160	14	14
Etabloc G 32-200/074	50	50	32	180	160	435	80	70	105	156	184	190	240	125	160	14	14
Etabloc G 32-250/224	68	50	32	225	180	535	100	95	108	204	234	250	320	160	200	14	11
Etabloc G 40-160/074	50	65	40	160	180	437	80	70	105	156	184	190	240	125	160	14	11
Etabloc G 40-200/114	52	65	40	160	180	486	100	70	153	184	135	212	265	140	180	14	11
Etabloc G 40-200/154	55	65	40	160	180	486	100	70	153	184	135	212	265	140	180	14	11
Etabloc G 40-250/224	71	65	40	225	180	535	100	95	108	204	234	250	320	160	200	14	11
Etabloc G 40-250/304	75	65	40	225	180	535	100	95	108	204	234	250	320	160	200	14	11
Etabloc G 40-315/304	96	65	40	250	225	556	125	95	106	204	234	280	345	160	200	14	11
Etabloc G 40-315/404	106	65	40	250	225	570	125	95	110	204	234	280	345	195	235	14	11
Etabloc G 50-160/074	52	65	50	180	160	455	100	70	105	156	184	212	265	125	165	14	11
Etabloc G 50-160/114	55	65	50	180	160	492	100	70	100	184	212	212	265	142	182	14	11
Etabloc G 50-160/154	57	65	50	180	160	492	100	70	100	184	212	212	265	142	182	14	11
Etabloc G 50-200/224	65	65	50	225	180	525	100	70	110	204	234	212	265	160	200	14	11
Etabloc G 50-250/224	79	65	50	225	180	535	100	95	108	340	369	250	315	160	200	14	11
Etabloc G 50-250/304	97	65	50	225	180	535	100	95	108	340	369	250	315	160	200	14	11
Etabloc G 50-250/404	105	65	50	225	180	535	100	95	102	204	234	250	315	195	235	14	11
Etabloc G 50-315/554	121	65	50	280	225	662	125	95	133	252	282	280	345	225	270	14	11
Etabloc G 50-315/754	130	65	50	280	225	662	125	95	133	252	282	280	345	225	270	14	11
Etabloc G 65-125/114	45	80	65	180	160	496	100	95	92	184	212	212	208	142	182	14	11
Etabloc G 65-125/154	47	80	65	180	160	496	100	95	92	184	212	212	208	142	182	14	11
Etabloc G 65-160/224	62	80	65	200	160	535	100	95	108	204	234	212	280	160	200	14	11
Etabloc G 65-200/404	99	80	65	225	180	537	100	95	103	204	234	250	320	195	235	14	11
Etabloc G 65-250/554	118	80	65	250	200	637	100	120	124	252	282	280	360	225	270	18	11
Etabloc G 65-250/754	127	80	65	250	200	637	100	120	121	252	282	280	360	225	270	18	11
Etabloc G 65-315/1104	151	80	65	280	225	780	125	120	138	340	369	315	400	264	309	18	11
Etabloc G 80-160/304	102	100	80	225	180	533	125	95	114	204	234	250	320	195	200	14	11
Etabloc G 80-200/404	111	100	80	250	180	571	125	95	111	204	234	280	345	195	200	14	11
Etabloc G 80-200/404	124	100	80	250	180	663	125	95	134	252	282	280	345	225	270	14	11
Etabloc G 80-250/404	138	100	80	280	200	571	125	120	111	204	234	315	400	195	200	18	11
Etabloc G 80-250/554	153	100	80	280	200	663	125	120	121	252	282	315	400	225	270	18	11
Etabloc G 80-250/754	158	100	80	280	200	663	125	120	121	252	282	315	400	225	270	18	11
Etabloc G 80-250/1104	162	100	80	280	200	780	125	120	136	340	369	315	400	264	309	18	11
Etabloc G 80-315/1104	164	100	80	315	250	780	125	120	136	340	369	315	400	264	309	18	11
Etabloc G 80-315/1504	179	100	80	315	250	780	125	120	136	340	369	315	400	264	309	18	11
Etabloc G 80-315/1854	262	100	80	315	250	830	125	120	155	360	369	315	400	280	360	18	11
Etabloc G 80-400/1854	270	100	80	355	280	850	125	120	182	360	396	355	435	280	360	18	11
Etabloc G 80-400/2204	290	100	80	355	280	850	125	120	182	360	396	355	435	280	360	18	11
Etabloc G 80-400/3004	350	100	80	355	280	998	125	120	251	425	485	355	435	309	396	18	18
Etabloc G 100-160/404	91	125	100	280	200	572	125	120	98	204	234	280	360	195	235	18	11
Etabloc G 100-200/754	140	125	100	280	200	663	125	120	120	252	282	280	354	226	271	18	11
Etabloc G 100-250/1104	180	125	100	280	225	795	140	120	137	340	369	315	400	252	297	18	11
Etabloc G 100-315/1504	185	125	100	315	250	795	140	120	136	340	369	315	400	264	309	18	11
Etabloc G 100-315/1854	270	125	100	315	250	835	140	120	139	360	396	315	400	279	350	18	11
Etabloc G 100-315/2204	310	125	100	315	250	835	140	120	139	360	396	315	400	279	350	18	11
Etabloc G 100-400/3004	380	125	100	355	280	1013	140	150	236	425	485	400	500	309	396	23	18
Etabloc G 100-400/3704	457	125	100	355	280	1076	140	150	282	431	491	400	500	340	436	23	18
Etabloc G 100-400/4504	480	125	100	355	280	1076	140	150	282	431	491	400	500	340	436	23	18
Etabloc G 125-250/1854	310	100	125	355	250	853	140	120	135	360	396	315	400	285	355	18	14
Etabloc G 150-200/1504	230	200	150	400	280	815	160	150	203	340	369	450	550	264	309	23	14
Etabloc G 150-250/3004	400	200	150	400	280	1025	160	150	226	425	485	450	550	309	396	23	18
Etabloc G 150-315/1854	330	200	150	400	280	908	160	150	158	360	396	450	550	278	348	14	23
Etabloc G 150-315/2204	350	200	150	400	280	908	160	150	158	360	396	450	550	278	348	14	23
Etabloc G 150-315/3004	410	200	150	400	280	1035	160	150	236	425	396	450	550	309	396	18	23
Etabloc G 150-315/3704	487	200	150	400	280	1035	160	150	282	431	396	450	550	340	436	18	23
Etabloc G 150-400/5504	652	200	150	450	315	1180	160	150	305	460	396	450	550	406	486	22	23
Etabloc G 150-400/7504	822	200	150	450	315	1309	160	150	326	535	396	450	550	457	536	22	23
Etabloc G 150-400/9004	887	200	150	450	315	1309	160	150	326	535	396	450	550	457	536	22	23

Electrical Data				
IP	Current (A) 3 Phase	Voltage (V)	Power (kw)	Speed (rpm)
54	2.15	380Y	0.75	1450
54	1.6	380Y	0.55	1450
54	2.15	380Y	0.75	1450
54	5.15	380Y	2.2	1450
54	2.15	380Y	0.75	1450
54	2.7	380Y	1.1	1450
54	3.7	380Y	1.5	1450
54	5.15	380Y	2.2	1450
54	6.95	380Y	3	1450
54	6.95	380Y	3	1450
54	8.7	380Δ	4	1450
54	2.15	380Y	0.75	1450
54	2.7	380Y	1.1	1450
54	3.7	380Y	1.5	1450
54	5.15	380Y	2.2	1450
54	5.15	380Y	2.2	1450
54	6.95	380Y	3	1450
54	8.7	380Δ	4	1450
54	12	380Δ	5.5	1450
54	16.2	380Δ	7.5	1450
54	2.7	380Y	1.1	1450
54	3.7	380Y	1.5	1450
54	5.15	380Y	2.2	1450
54	8.7	380Δ	4	1450
54	12	380Δ	5.5	1450
54	16.2	380Δ	7.5	1450
54	22.6	380Δ	11	1450
54	6.95	380Y	3	1450
54	8.7	380Δ	4	1450
54	12	380Δ	5.5	1450
54	8.7	380Δ	4	1450
54	12	380Δ	5.5	1450
54	16.2	380Δ	7.5	1450
54	22.6	380Δ	11	1450
54	22.6	380Δ	11	1450
54	22.6	380Δ	11	1450
54	29.8	380Δ	15	1450
54	36.4	380Δ	18.5	1450
54	36.4	380Δ	18.5	1450
54	42.3	380Δ	22	1450
54	54.4	380Δ	30	1450
54	8.7	380Δ	4	1450
54	16.2	380Δ	7.5	1450
54	22.6	380Δ	11	1450
54	29.8	380Δ	15	1450
54	36.4	380Δ	18.5	1450
54	42.3	380Δ	22	1450
54	54.4	380Δ	30	1450
54	67.9	380Δ	37	1450
54	82.6	380Δ	45	1450
54	36.4	380Δ	18.5	1450
54	29.8	380Δ	15	1450
54	54.4	380Δ	30	1450
54	54.4	380Δ	30	1450
54	97.7	380Δ	55	1450
54	137.6	380Δ	75	1450
54	163.3	380Δ	90	1450

منحنی‌های همپوشانی الکترومپ‌ها

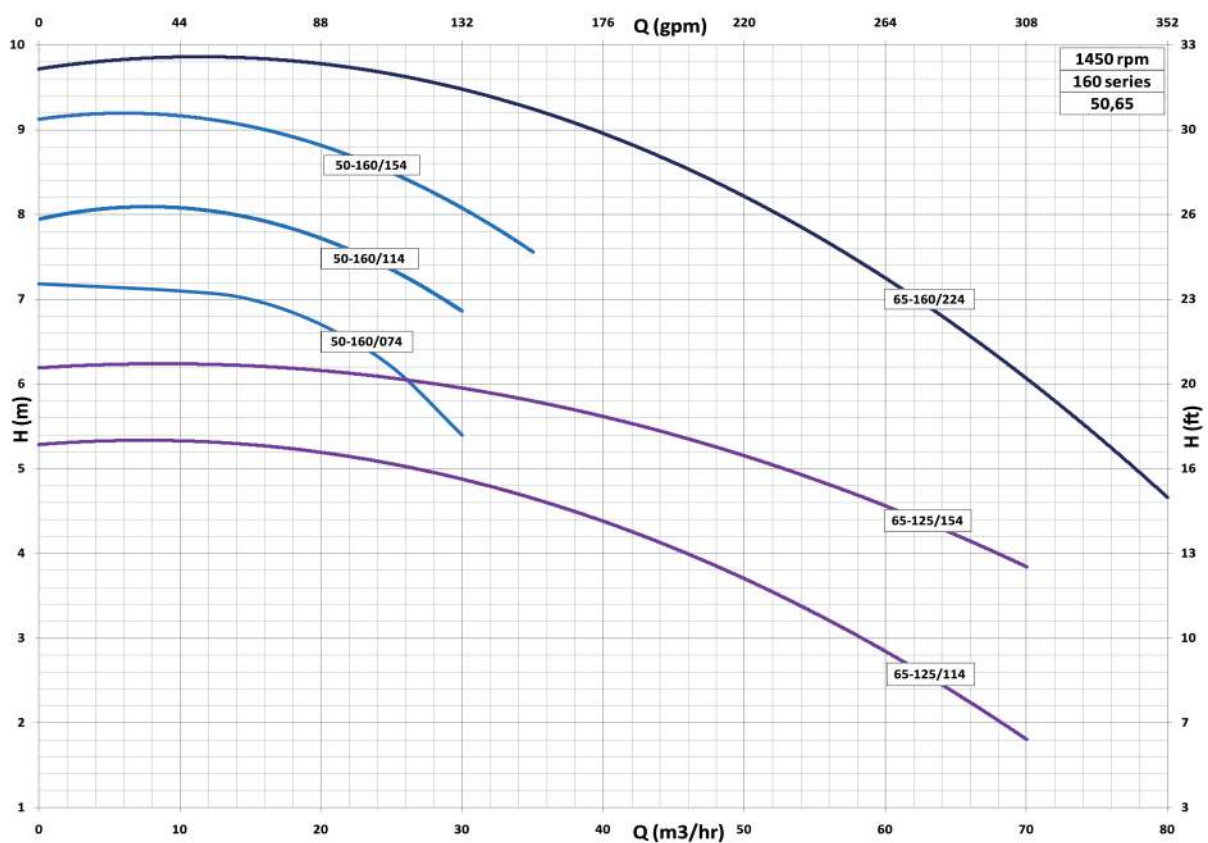
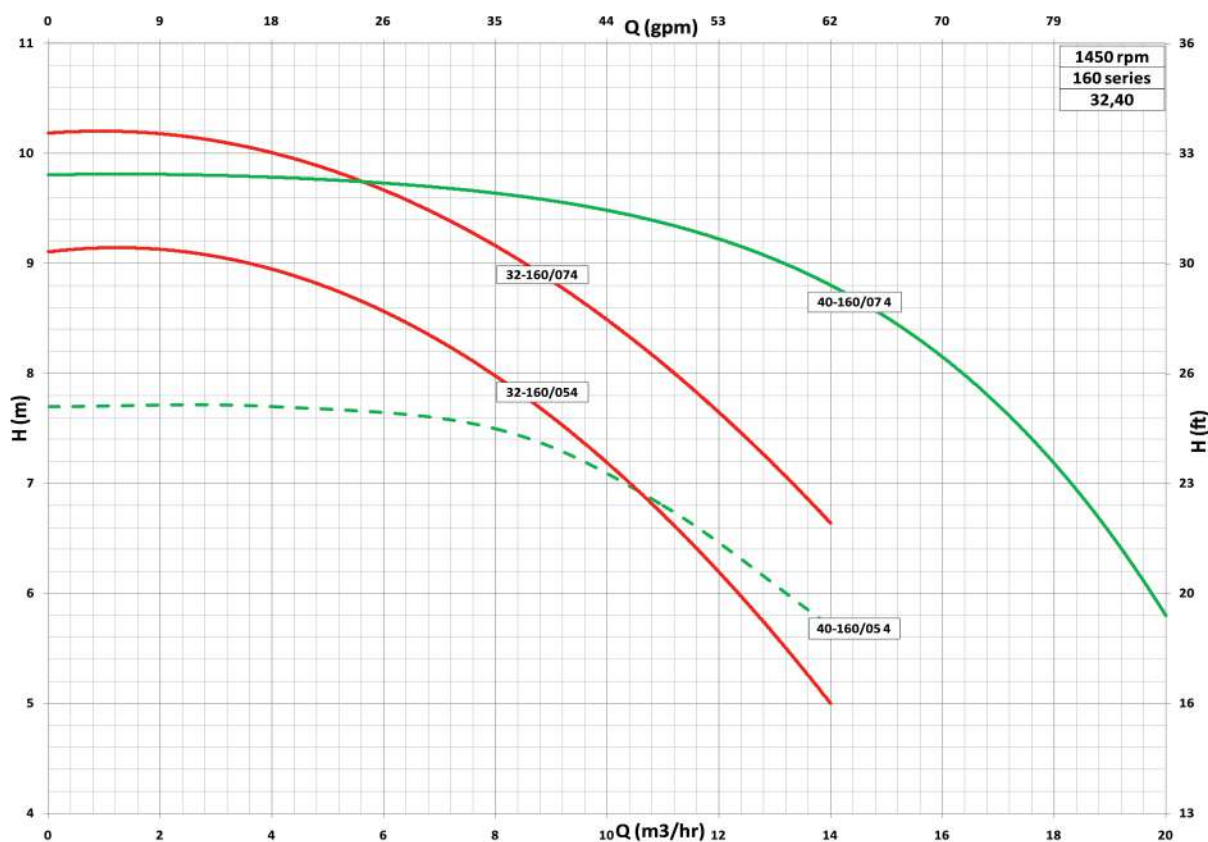

منحنی‌های همپوشانی الکتروپمپ‌ها

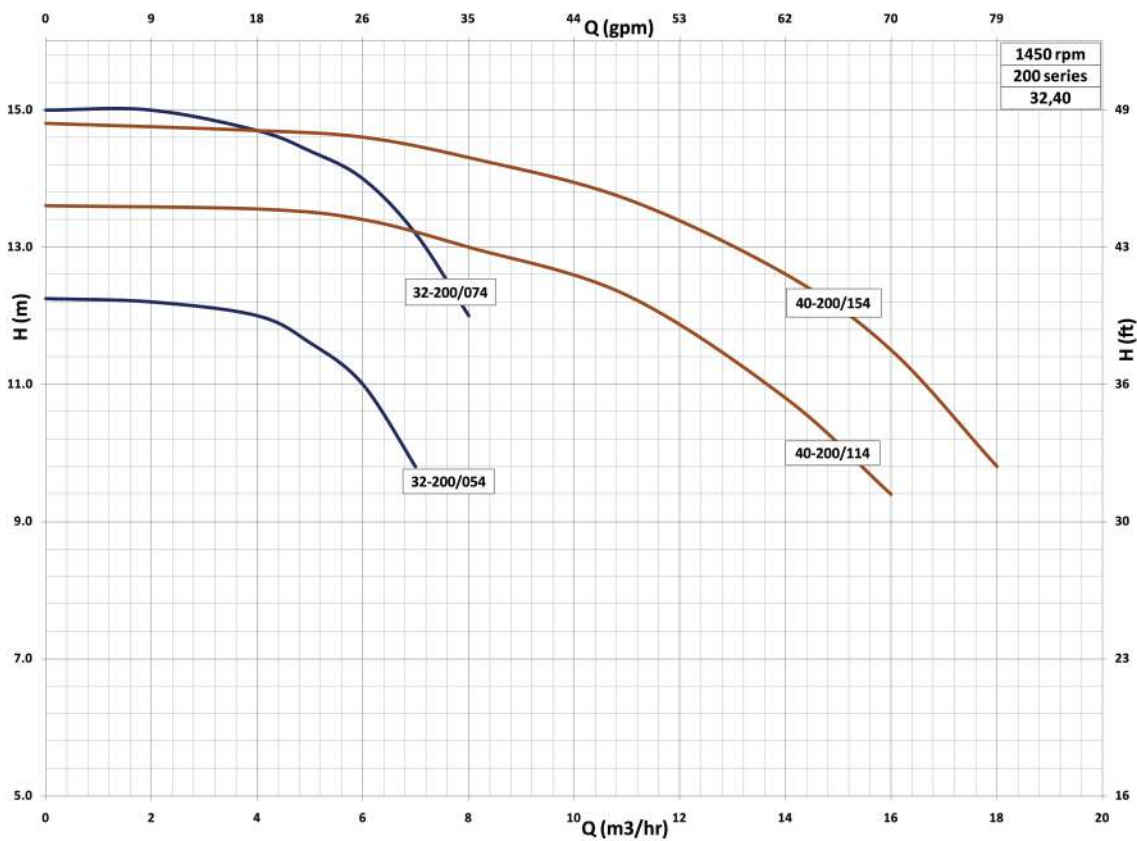
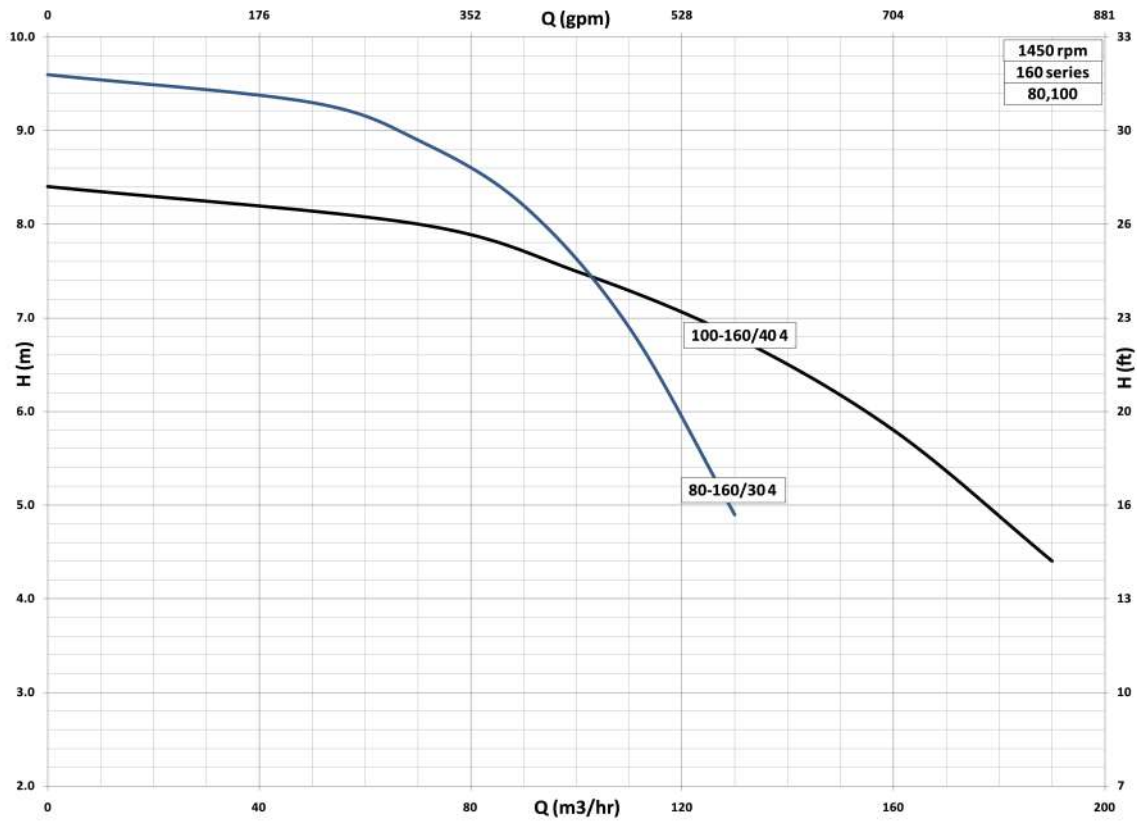

منحنی‌های همپوشانی الکتروپمپ‌ها

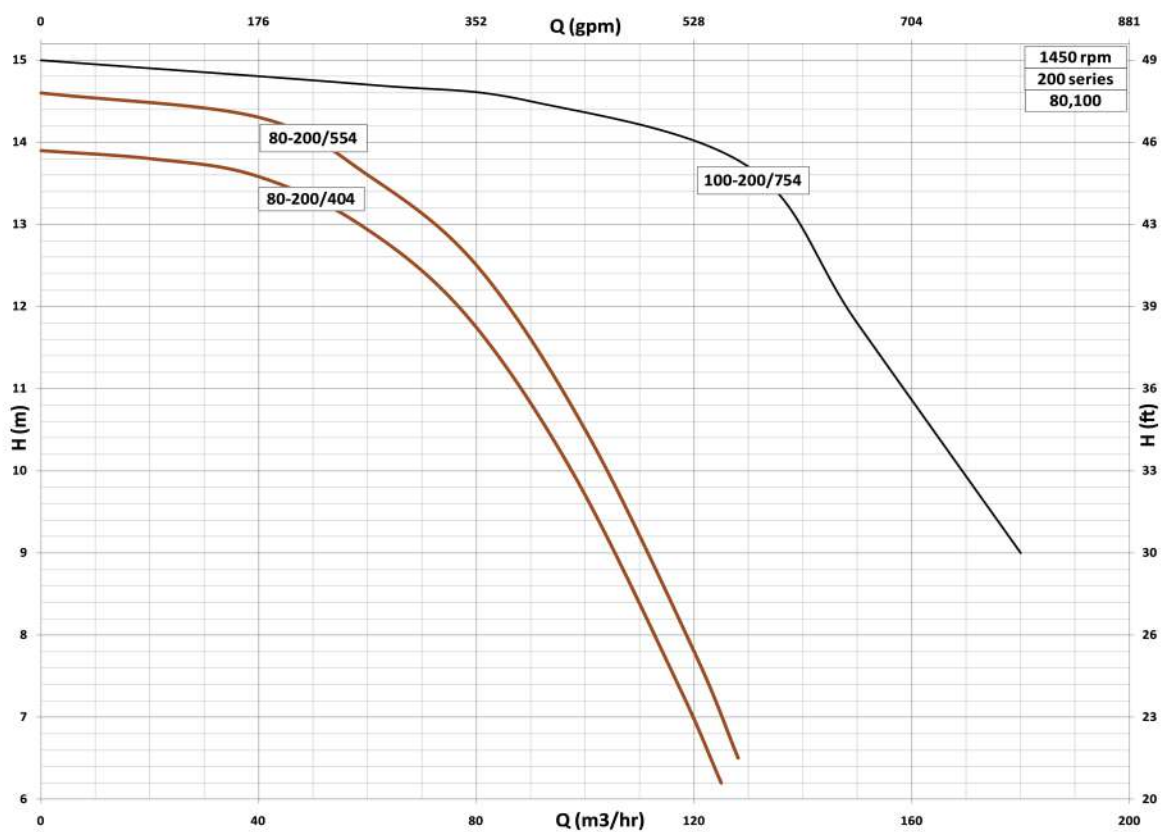
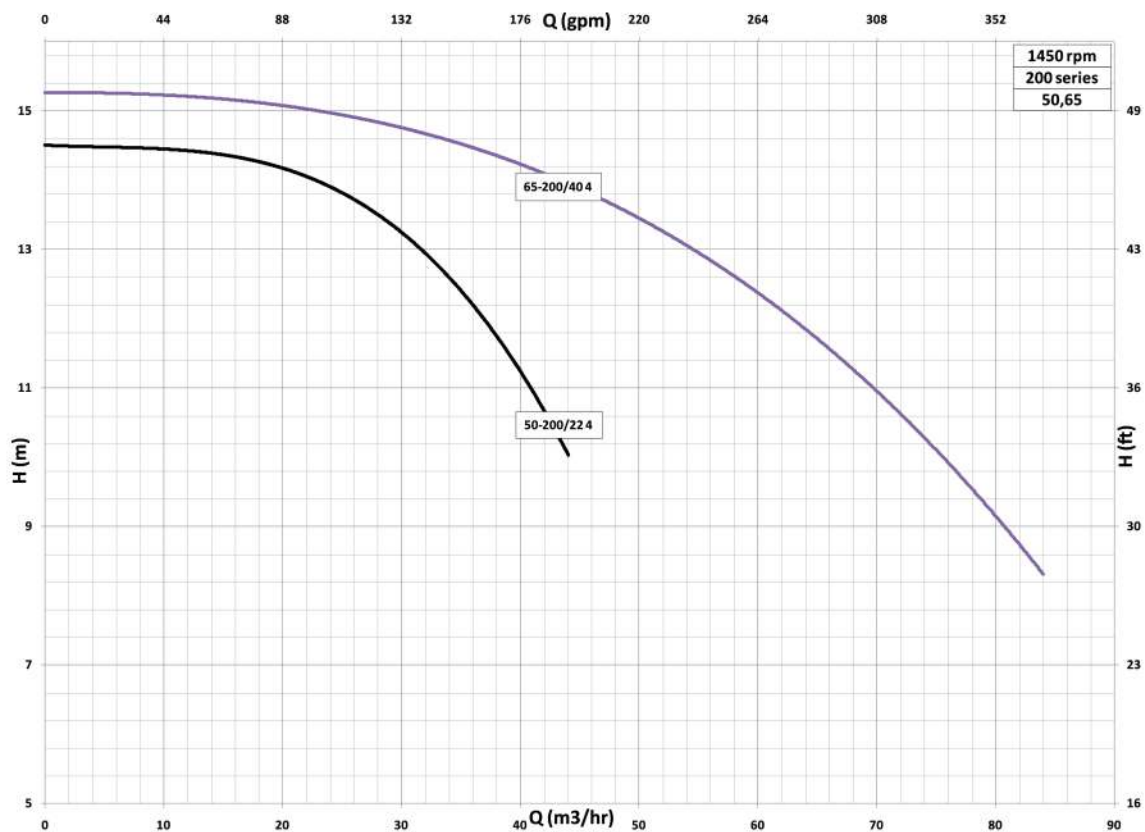

منحنی‌های همپوشانی الکتروپمپ‌ها

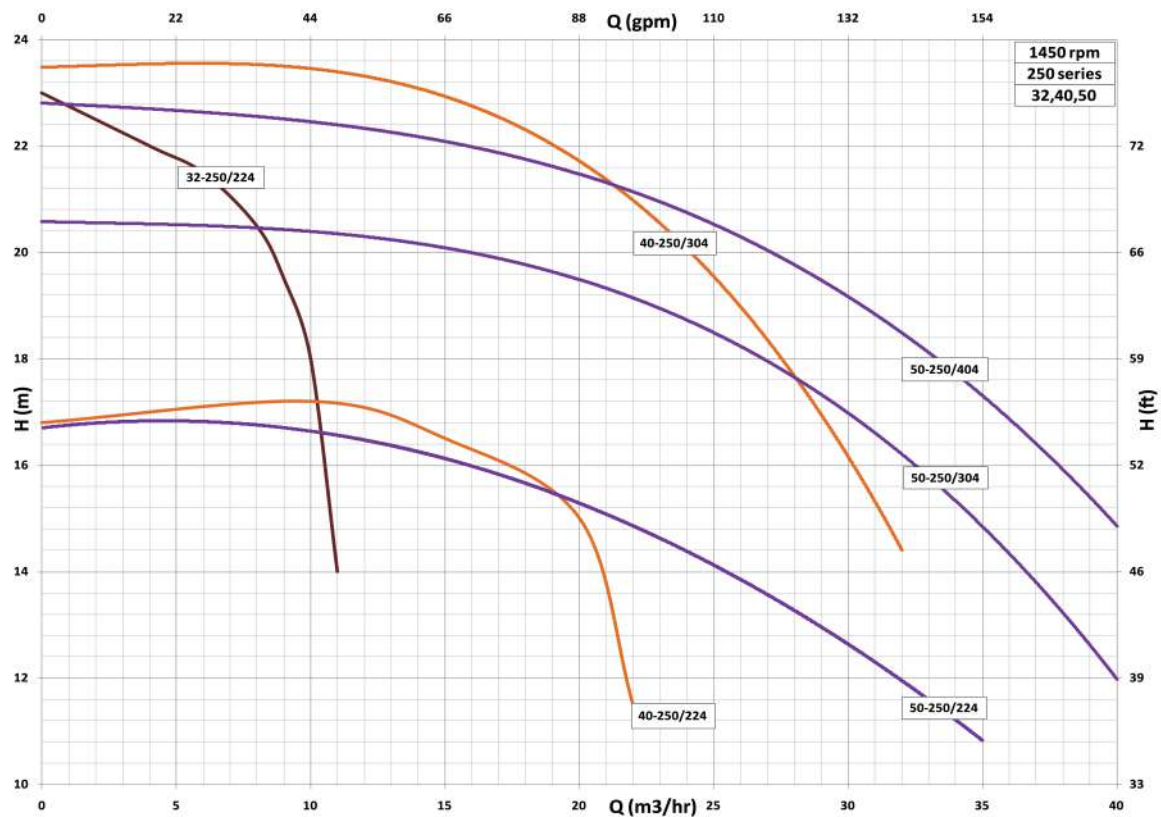
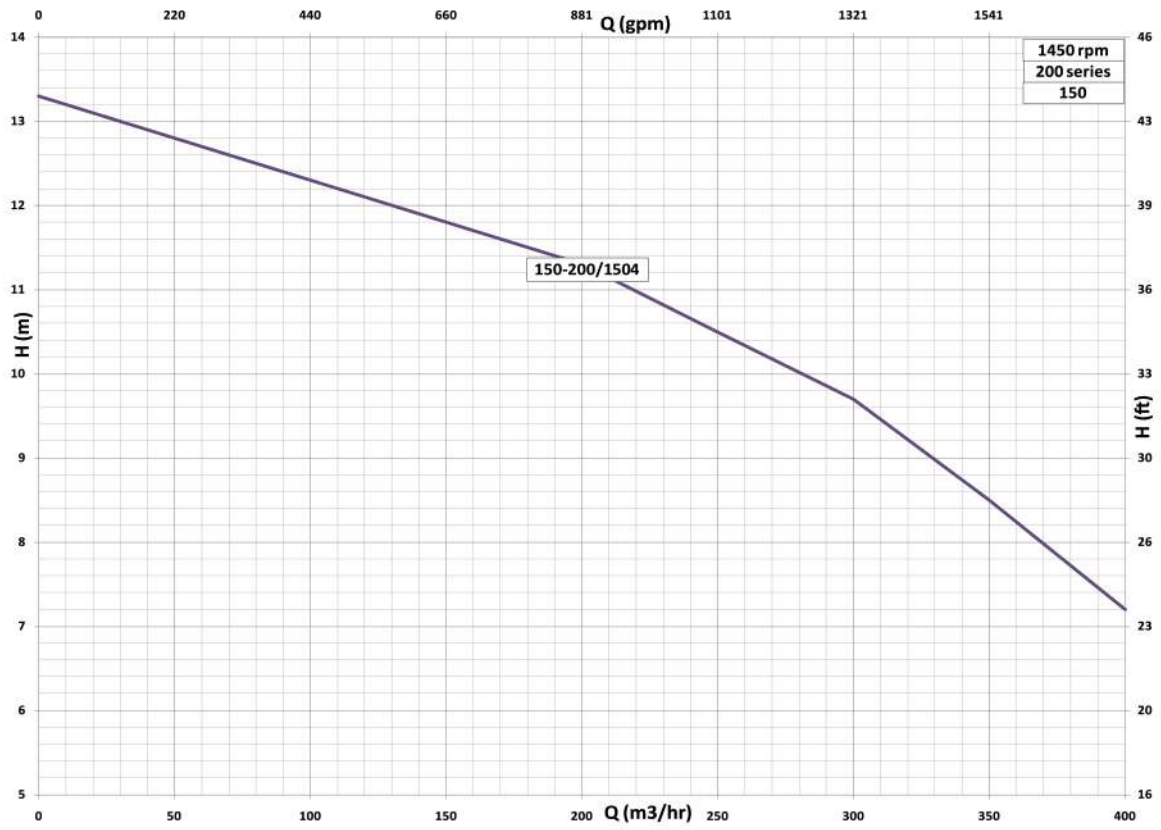

منحنی‌های همپوشانی الکتروپمپ‌ها

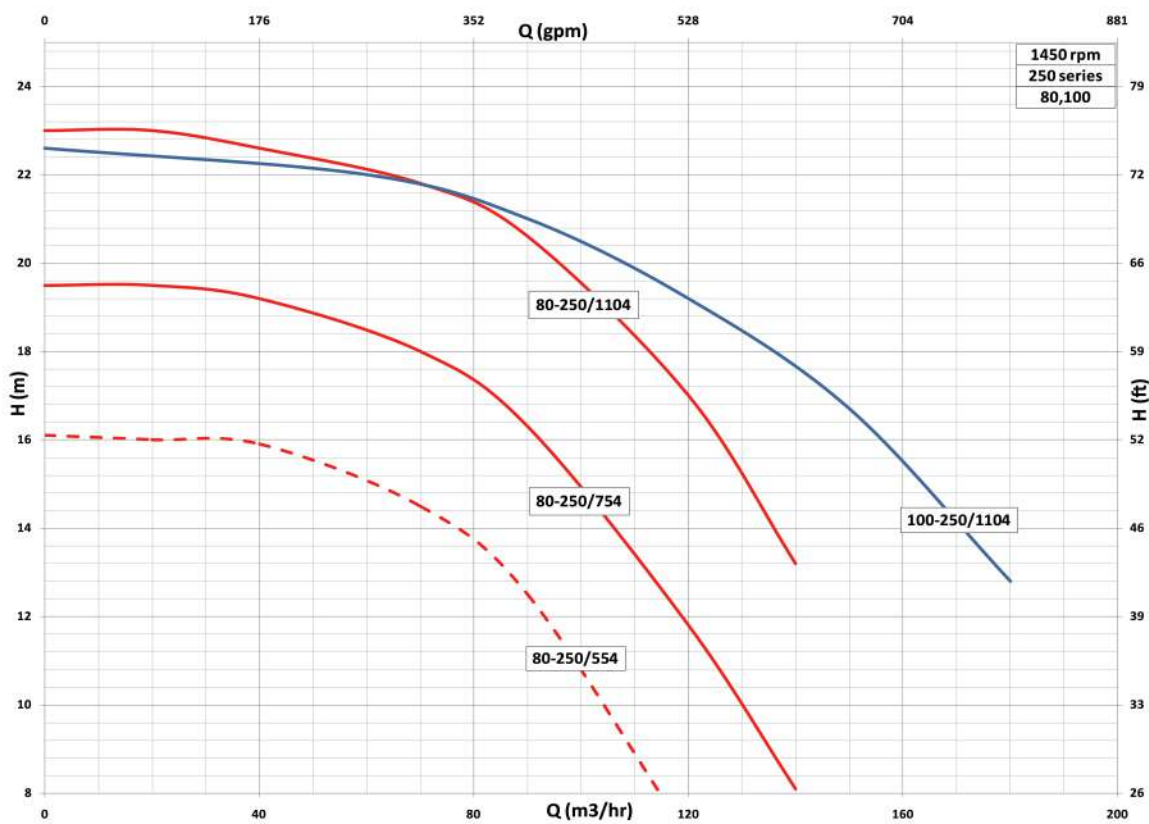
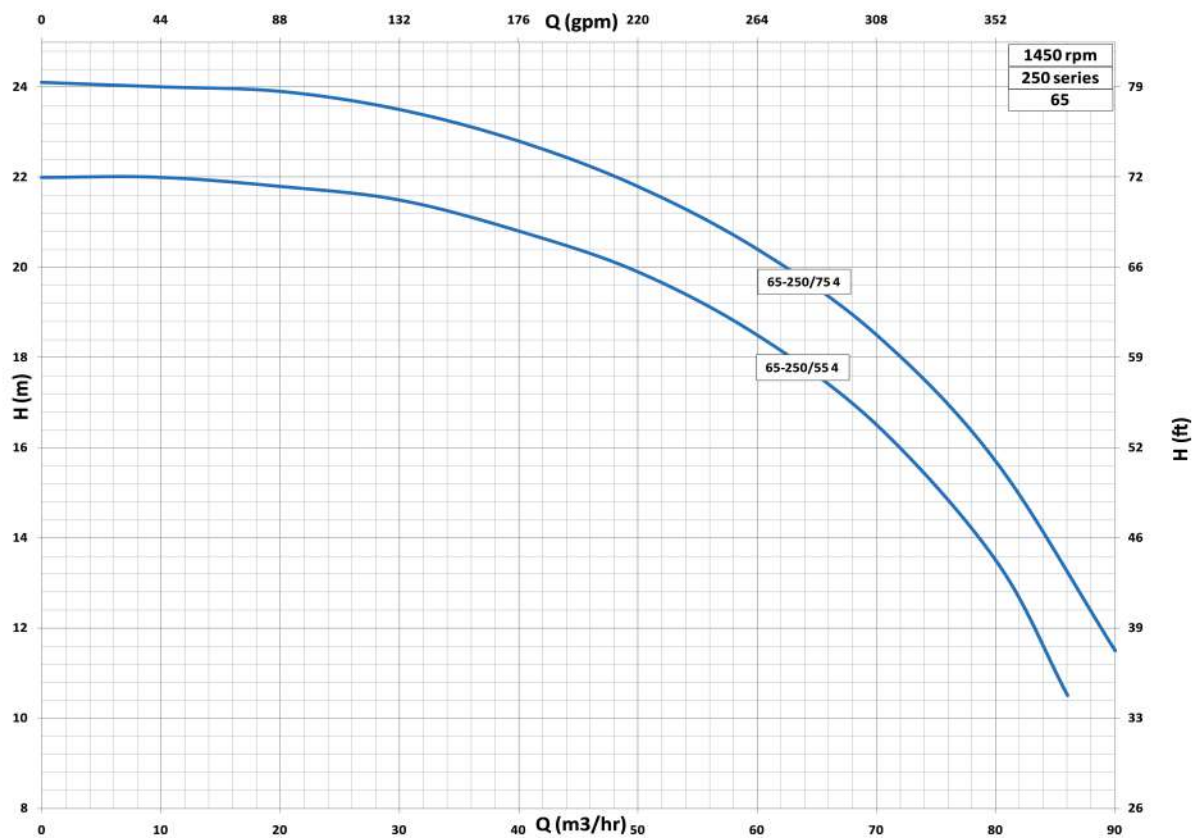

منحنی‌های همپوشانی الکتروپمپ‌ها

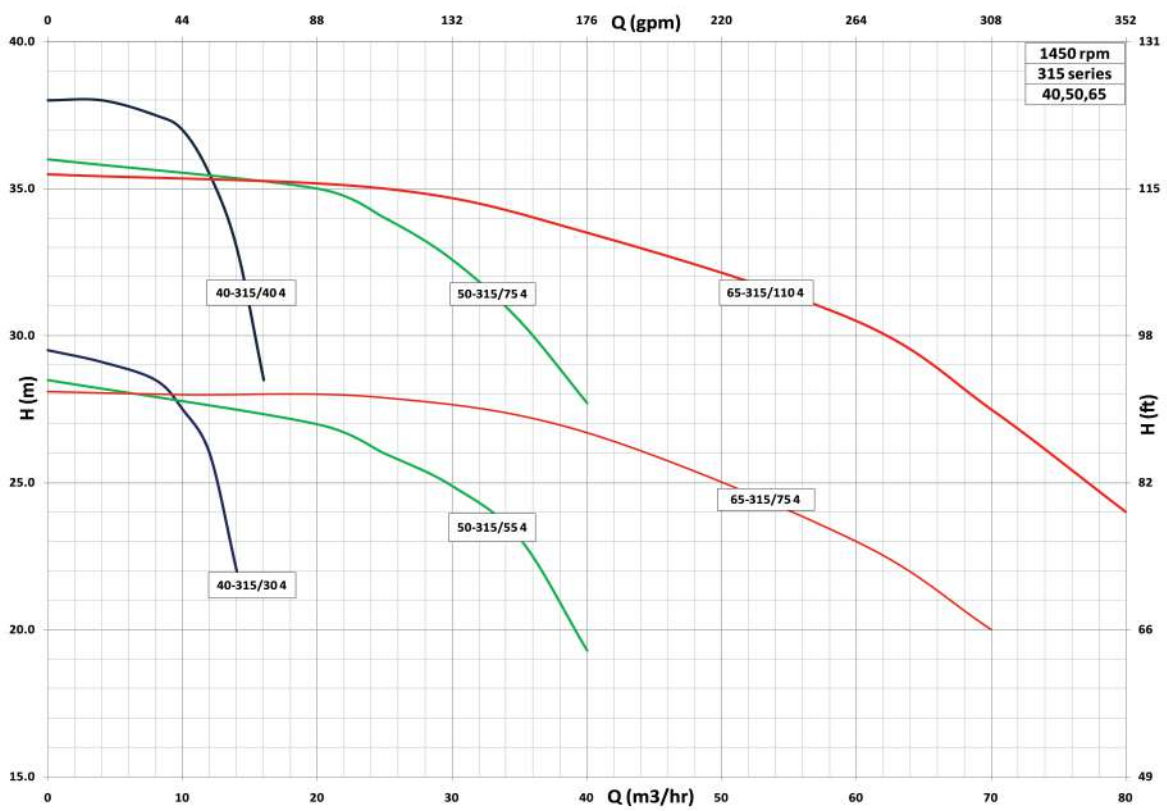

منحنی‌های همپوشانی الکتروپمپ‌ها

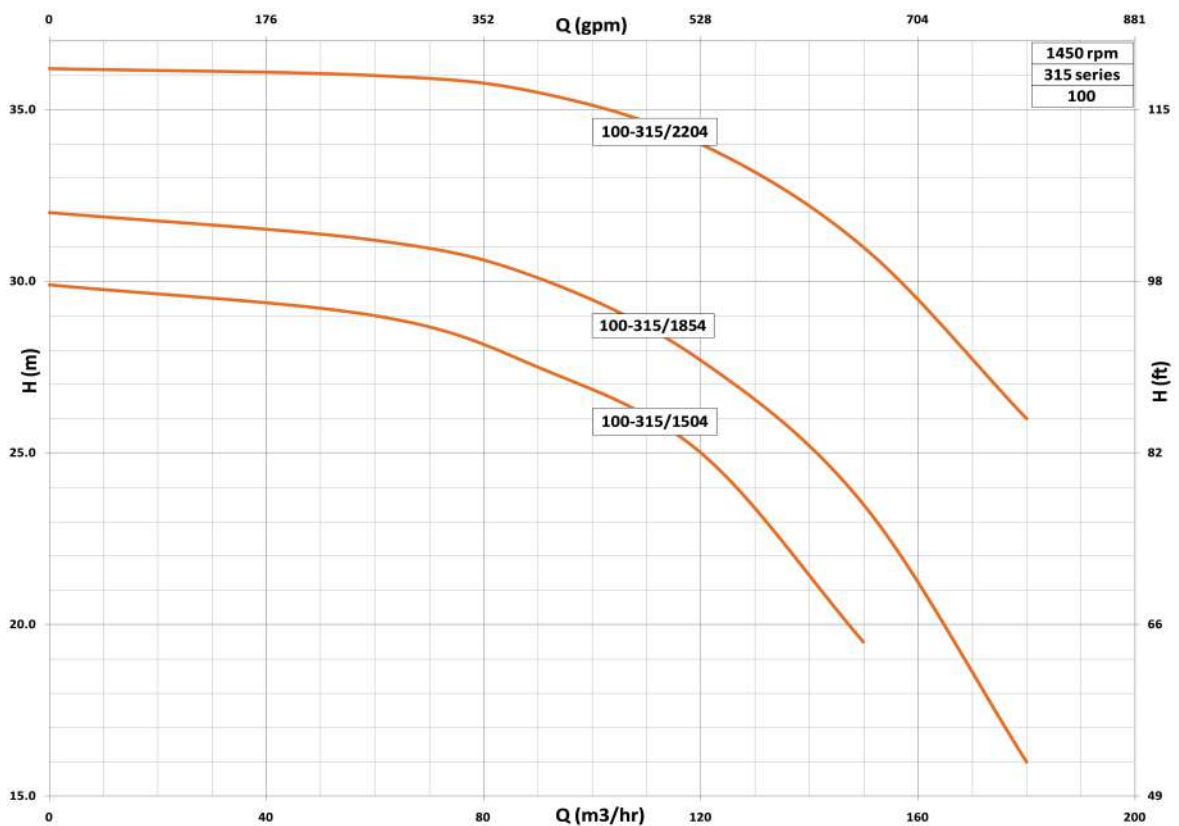
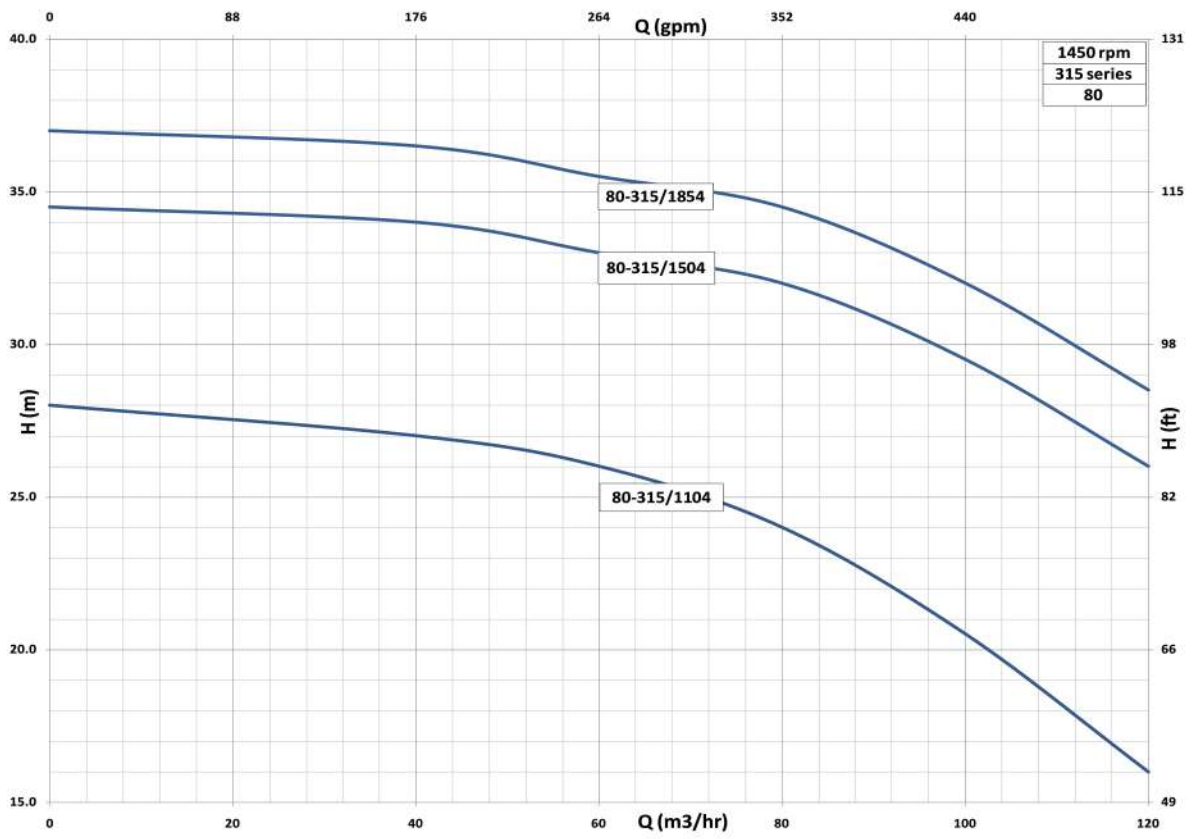

منحنی‌های همپوشانی الکتروپمپ‌ها

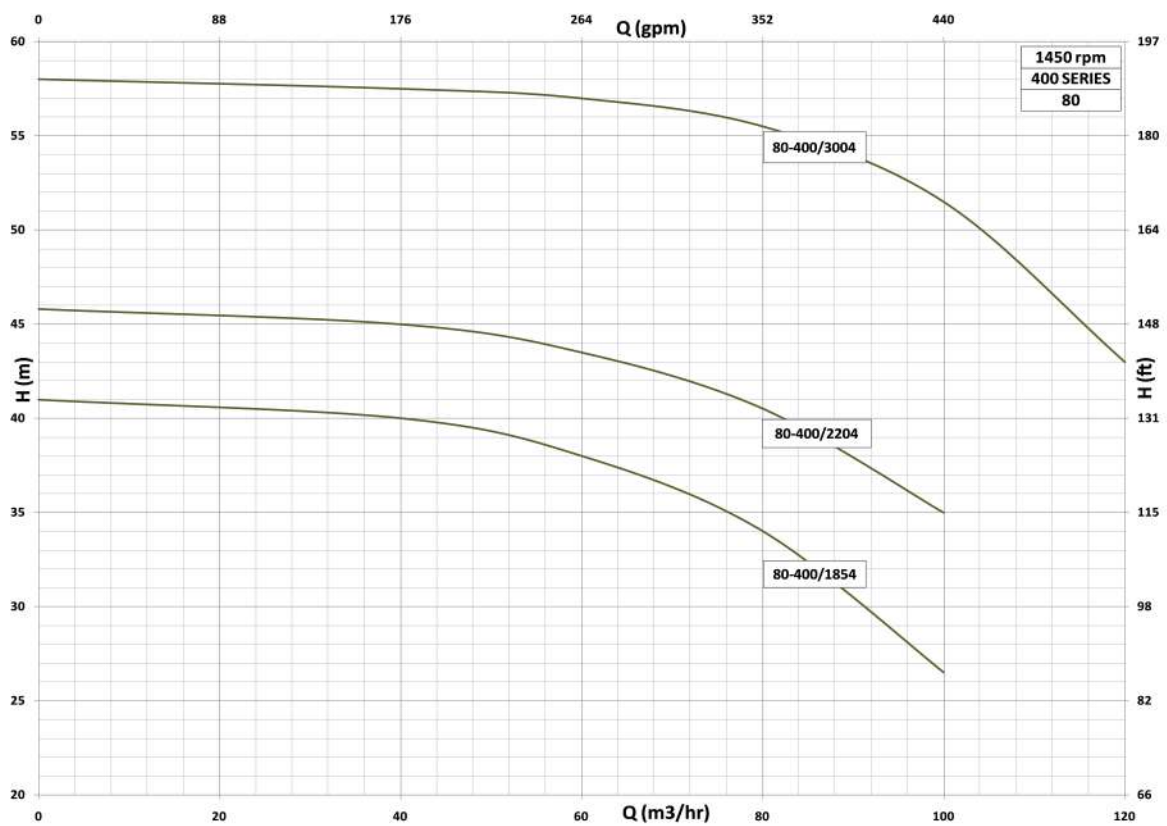
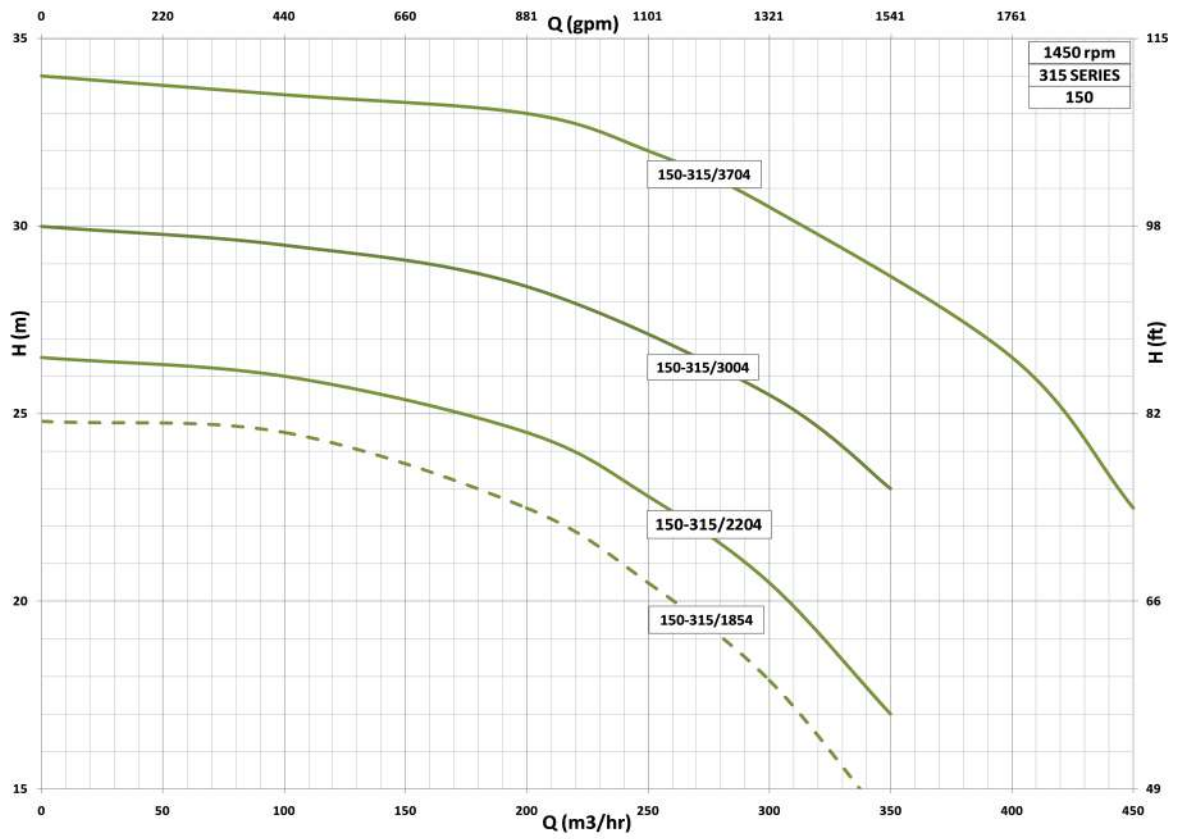

منحنی‌های همپوشانی الکتروپمپ‌ها

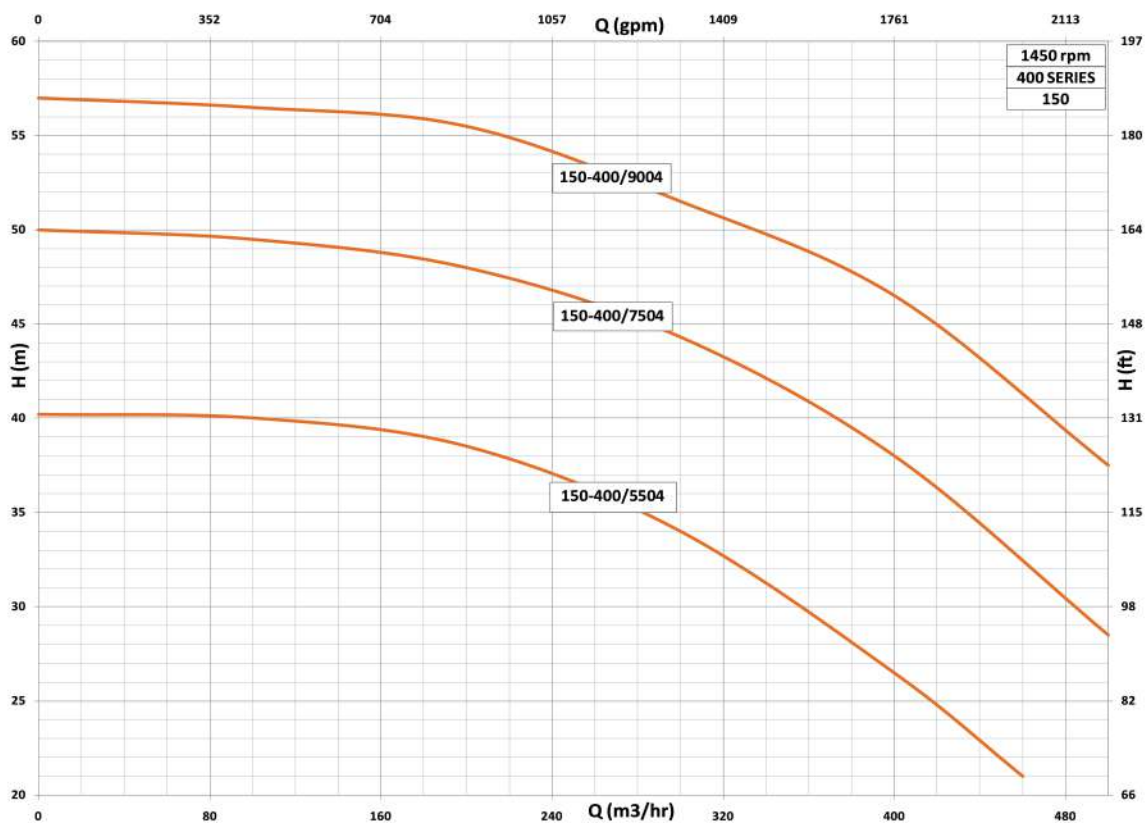
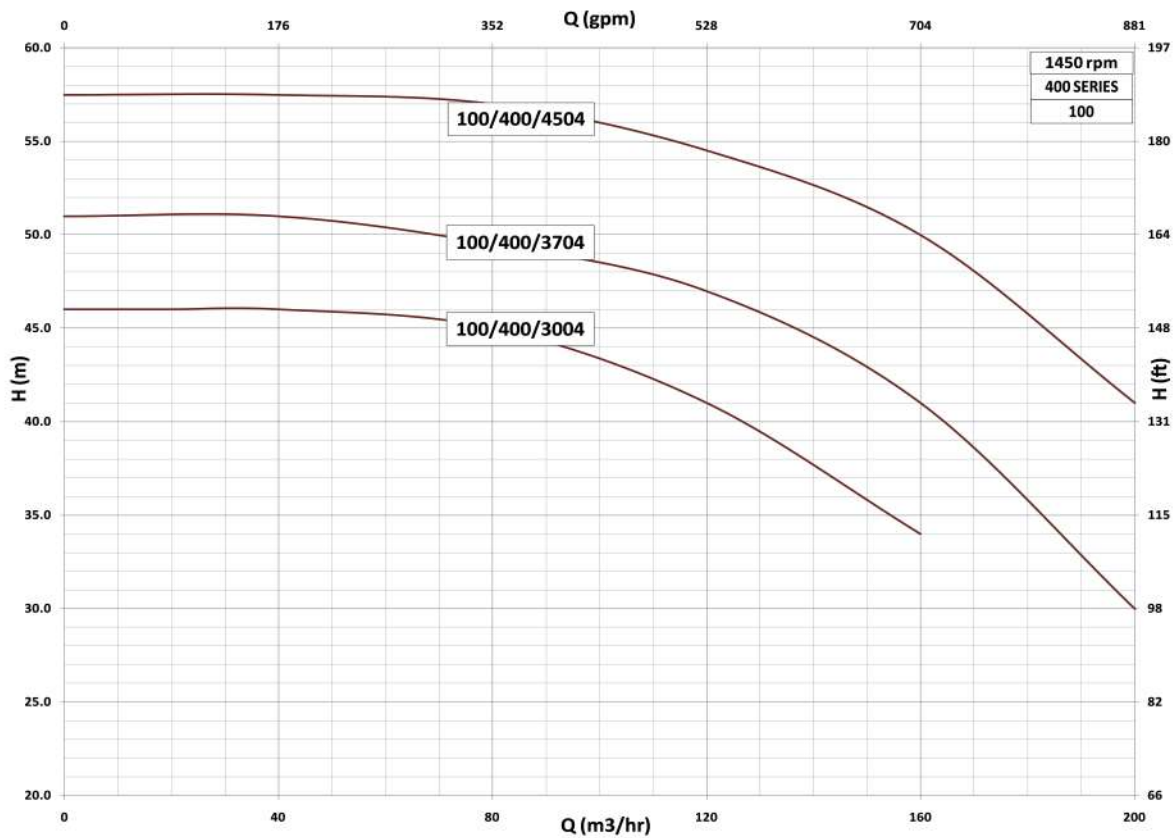

جدول مشخصات اتابلوک های آتشنشانی مطابق با استاندارد NFPA20

Etabloc Pump		Pump Dimension(mm)																Electrical Data				
Pump Type	Weight (kg)	DN1	DN2	h1	h2	L	a	n1	n2	n3	n4	m1	m2	m3	m4	d2	d1	IP	Curent (A) 3 Phase	Voltage (V)	Power (kw)	Speed (rpm)
Etabloc B 32-200/402	66	50	32	180	160	514	80	70	109	204	234	190	240	195	235	14	11	54	9	380Δ	4	2900
Etabloc B 32-200/552	79	50	32	180	160	592	80	100	117	252	282	190	240	225	270	14	11	54	11.6	380Δ	5.5	2900
Etabloc B 32-250/752	95	50	32	225	180	627	100	95	123	252	282	250	320	225	270	14	11	54	15.6	380Δ	7.5	2900
Etabloc B 32-250/1102	126	50	32	225	180	742	100	95	136	340	369	250	320	264	320	14	11	54	21.3	380Δ	11	2900
Etabloc B 32-250/1502	142	50	32	225	180	742	100	95	136	340	369	250	320	264	320	14	11	54	29	380Δ	15	2900
Etabloc B 40-160/552	80	65	40	180	160	610	80	70	174	178	252	190	240	225	270	14	11	54	11.6	380Δ	5.5	2900
Etabloc B 40-200/552	81	65	40	180	160	617	100	70	125	252	282	212	265	225	270	14	11	54	11.6	380Δ	5.5	2900
Etabloc B 40-200/752	86	65	40	180	160	617	100	70	125	252	282	212	265	225	270	14	11	54	15.6	380Δ	7.5	2900
Etabloc B 40-200/1102	115	65	40	180	160	742	100	70	191	255	305	212	265	250	320	14	15	54	21.3	380Δ	11	2900
Etabloc B 40-250/1102	132	65	40	225	180	742	100	95	136	340	369	250	320	264	320	14	11	54	21.3	380Δ	11	2900
Etabloc B 40-250/1502	147	65	40	225	180	742	100	95	136	340	369	250	320	264	320	14	11	54	29	380Δ	15	2900
Etabloc B 40-250/1852	150	65	40	225	180	742	100	95	136	282	369	250	320	285	320	14	11	54	36.3	380Δ	18.5	2900
Etabloc B 40-250/2202	223	65	40	225	180	805	100	95	192	282	330	250	320	285	360	14	14	54	42.3	380Δ	22	2900
Etabloc B 50-160/552	82	65	50	180	160	630	100	70	137	252	282	212	265	225	270	14	11	54	11.6	380Δ	5.5	2900
Etabloc B 50-160/752	87	65	50	180	160	630	100	70	137	252	282	212	265	225	270	14	11	54	15.6	380Δ	7.5	2900
Etabloc B 50-200/1102	115	65	50	200	160	742	100	75	191	255	305	212	320	262	320	14	15	54	21.3	380Δ	11	2900
Etabloc B 50-200/1502	132	65	50	200	160	742	100	75	191	255	305	212	320	262	320	14	15	54	29	380Δ	15	2900
Etabloc B 50-200/1852	135	65	50	200	160	742	100	75	191	255	305	212	320	262	310	14	15	54	36.3	380Δ	18.5	2900
Etabloc B 50-250/1102	116	65	50	225	180	742	100	95	136	340	369	250	315	264	310	14	11	54	21.3	380Δ	11	2900
Etabloc B 50-250/1502	131	65	50	225	180	742	100	95	136	340	369	250	315	264	310	14	11	54	29	380Δ	15	2900
Etabloc B 50-250/1852	142	65	50	225	180	742	100	95	136	340	369	250	315	264	310	14	11	54	36.3	380Δ	18.5	2900
Etabloc B 50-250/2202	227	65	50	225	180	810	100	95	192	282	330	250	315	285	360	14	14	54	42.3	380Δ	22	2900
Etabloc B 50-250/3002	290	65	50	225	200	953	100	95	304	305	365	250	315	335	396	18	14	54	54.4	380Δ	30	2900
Etabloc B 65-200/2202	230	80	65	225	180	790	100	95	190	282	330	250	320	279	360	14	14	54	42.3	380Δ	22	2900
Etabloc B 65-250/3002	310	80	65	250	200	963	100	120	301	305	365	280	360	335	396	18	18	54	54.4	380Δ	30	2900
Etabloc B 65-250/3702	335	80	65	250	300	963	100	120	301	305	365	280	360	335	396	18	18	54	67.9	380Δ	37	2900
Etabloc B 65-250/4502	395	80	65	250	225	993	100	120	317	311	371	280	360	356	436	18	18	54	82.6	380Δ	45	2900
Etabloc B 65-250/5502	500	80	65	250	280	1108	100	120	271	449	485	280	360	388	486	18	18	54	97.7	380Δ	55	2900
Etabloc B 80-200/2202	262	100	80	250	180	825	125	95	195	279	330	280	345	285	360	14	14	54	42.3	380Δ	22	2900
Etabloc B 80-200/3002	314	100	80	250	200	987	125	95	314	305	365	280	345	320	396	14	18	54	54.4	380Δ	30	2900
Etabloc B 80-200/3702	338	100	80	250	200	987	125	95	314	305	365	280	345	320	396	14	18	54	67.9	380Δ	37	2900

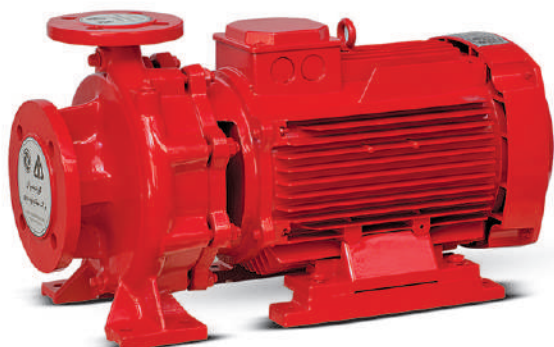

- هد و دبی منطبق با جداول ارائه شده NFPA20
- متریال منطبق با استاندارد NFPA20
- تست شده با فشار 16 بار
- دارای مکانیکال سیل
- دارای شفت مستقیم
- بدون لرزش
- بدون صدا
- IP55